



ENGINEERS  
AUSTRALIA

# EHA MAGAZINE



# Engineering Heritage Australia Magazine

ISSN 2206-0200 (Online)

September 2022  
Volume 4 Number 3

## EDITOR:

Margret Doring, FIEAust. CPEng. M.ICOMOS

The Engineering Heritage Australia Magazine is published by Engineers Australia's National Committee for Engineering Heritage. Statements made or opinions expressed in the Magazine are those of the authors and do not necessarily reflect the views of Engineers Australia.

Contact EHA by email at:

[EHA@engineersaustralia.org.au](mailto:EHA@engineersaustralia.org.au)

or visit the website at:

<https://www.engineersaustralia.org.au/Communities-And-Groups/Special-Interest-Groups/Engineering-Heritage-Australia>

Unsubscribe: If you do not wish to receive any further material from Engineering Heritage Australia, contact EHA at :

[EHA@engineersaustralia.org.au](mailto:EHA@engineersaustralia.org.au)

Subscribe: Readers who want to be added to the subscriber list can contact EHA via our email at :

[EHA@engineersaustralia.org.au](mailto:EHA@engineersaustralia.org.au)

Readers wishing to submit material for publication in the Engineering Heritage Australia Magazine, can contact the Editor via email at :

[EHA@engineersaustralia.org.au](mailto:EHA@engineersaustralia.org.au)

## Cover Image:

"Parkes in Springtime", October 1994.  
by John Sarkissian

The CSIRO Parkes Radio Telescope, Australia's premier scientific instrument, turned 60 years old in 2021.

It is still doing world-class science and making discoveries that are shaping our understanding of the Universe.

This is a free magazine covering stories and news items about industrial and engineering heritage in Australia and elsewhere. It is published online as a down-loadable PDF document for readers to view on screen or print their own copies. EA members and non-members on the EHA mailing lists will receive emails notifying them of new issues, with a link to the relevant Engineers Australia website page.

---

## CONTENTS

Editorial	3
Engineering Heritage of the Walsh Bay Arts Precinct	4
The Amiens Gun from World War 1	10
The Miles Lewis Heritage Building Materials Collection	17
Otto Schumacher & his Mill Furnishing Works	18
Portable Engineering (& World Heritage)	25
CSIRO's Parkes Telescope: 60, & still going strong.	32

---

A recent EA Book  
"Reshaping the Hunter", By Evan McHugh



"Reshaping the Hunter" explores how globalisation, technological change, environmental concerns, and other factors have changed the face of the Hunter region in NSW. This book demonstrates how the engineers of today have been able to adapt, survive and thrive, just as their forebears have done.

To learn more: <https://www.rahs.org.au/reshaping-the-hunter/>

[Purchase Reshaping the Hunter](#)

# Editorial

We have a bumper crop of stories for you this issue – two by new writers and three by past contributors. I found some interesting (to me) overlapping connections between the topics in this issue, and some other earlier magazine stories. One story has a particular interest to me from my work long ago, and I have a long ago connection with one of the authors, who had some influence on my career trajectory.

We start with the *Engineering Heritage of the Walsh Bay Arts Precinct*, by Peter Tonkin, an architect and principal of the well known Sydney firm Tonkin Zulaikha Greer (TZG). Peter and his firm won several Heritage Awards for their work on the restoration and recycling of two of the Walsh Bay wharves – Pier 2/3 and Wharf 4/5. I first heard of this when I read an article in the Newsletter *ArchitectureAU*. One of the things that arrested my attention was that TZG had succeeded in preserving much of the engineering heritage of these industrial sites, for display to future generations of Sydneysiders amid their beautiful theatres and concert halls. I was delighted.

Way back in the distant past, when I worked for the NSW Heritage Council, I was engaged by the (then) Maritime Services Board in Sydney to write a new set of Heritage Conservation Guidelines for the future development of the Walsh Bay wharves and their surroundings, that took account of their heritage value (including their engineering and industrial heritage). I spent many days researching and exploring the wharves, where I could get access, and formulating my conclusions. I was disappointed that my report didn't lead to any sort of statutory protection at the time, and over the following years a number of significant items in the area were demolished or compromised – notably Wharf 6/7. However, in 1999, long after I had left the field, that whole area now known as the Walsh Bay Precinct was added to the NSW Heritage Register. Perhaps someone had dredged my original report from whatever oblivion it had been buried in? Maybe – or was it just that heritage conservation was becoming fashionable in some circles? I like to think I might have had some indirect influence on what has happened since 1999. When I read that report in *ArchitectureAU*, I felt that someone must have been following my recommendations all along. I immediately got in touch with Peter Tonkin, explained my interest, and asked him to write us a story, which you can read here.

Bill Phippen is one of our stalwarts, and his *The Amiens Gun from World War 1*, written with Geoff Lillico, is one out of the box. What happened to that great German railway gun after it got to Australia, is almost beyond belief. It is a perfect illustration of the lack of respect afforded to most movable engineering heritage in this country – unless it's a veteran motor car or a famous locomotive. Bill and Geoff are to be congratulated for recording this extraordinary story of a gun most of us these days have never heard of. A sad story really, and one about its diminishing significance as its various components are gradually whittled away and destroyed. One wonders how long it will be before the AWM decides the remnants are surplus to requirements – and so out it goes.

With *Otto Schumacher & his Mill Furnishing Works*, David Radcliffe continues his exploration of the industrial history of Port Melbourne. I thought I knew all about Port Melbourne from weekly tours of the area with my businessman Grandfather through the war years, visiting factories, watching ships come and go – even seeing my Dad sail on the *Mauretania* to the Middle East in 1940 from Station Pier. But no, that was a superficial knowledge. I knew nothing of *Malcolm Moore & Albert Longoni* (see the January 2021 issue), nor of *Alfred Thomas Harman & the Port Melbourne Engineering Works* (see the January 2022 issue). I had no idea Port Melbourne had harboured so many great industrial ventures and so much engineering history – and I think David might have more to come?

Some time ago, someone sent me a paper about CSIRO's Parkes Radio Telescope, written by one John Sarkissian. It was interesting, so I tracked Sarkissian down, and asked if I could republish it in the magazine. He went one better, and offered to write an updated version, especially for us, and *CSIRO's Parkes Telescope: 60 years old & still going strong* is the result. I hope you enjoy it.

Lastly, I come to Professor Miles Lewis's *Portable Engineering* (page 25). Miles has been a principal proponent of a campaign to obtain UNESCO World Heritage listing for all the surviving 'portable' [prefabricated] buildings brought to Australia in the nineteenth century. I prevailed on him to write us a story for the magazine, about surviving portable structures in Australia that were of some engineering significance, and *Portable Engineering* is the result. My connection with Miles goes back a long way. Back in the 1970s, he was my lecturer in the subject *Architectural History*, which I studied as a sideline to my BE subjects. It turned out to have been incredibly useful in my short teaching career, and in my later ventures into heritage conservation. In 1982 I applied for a scholarship to study Architectural Conservation in Rome. I won, and Miles just happened to be one of the judges, so I have him to thank for my later career in engineering heritage! Way back then, Miles had already started his amazing collection of Heritage Building Materials, and it has kept growing. It was pure chance that I came across the Melbourne Uni web site that I refer to on page 17. It is a mine of information – enjoy.

**Margret J. Doring, Editor.**

# Engineering Heritage of the Walsh Bay Arts Precinct

By Dr Peter Tonkin, Architect.<sup>1</sup>

The Walsh Bay Arts Precinct involves the adaptive re-use of two extensive heritage listed timber wharves dating from the early 20th Century. Situated in a renewed industrial area adjoining the Sydney CBD, the project is a key part of the 'Cultural Ribbon' of arts venues along the waterfront from the Opera House. It is a significant addition to the cultural life of Sydney as the home for nine of Australia's premier arts companies, uniting performance, production and administration in spaces accessible to the public and of the highest technical quality.

The project comprises Pier 2/3 and Wharf 4/5 at Hickson Road in Walsh Bay. Pier 2/3 is a two level wharf structure, built between 1912 and 1923, and prior to the refurbishment, it was Sydney's last wharf structure to remain in its original maritime use state with minimal subdivision and services. Wharf 4/5 was completed in 1922 and was altered in the early 1980s to accommodate the Sydney Dance Company, Sydney Theatre Company, Bangarra Dance Company and the Australian Theatre for Young People. The somewhat idiosyncratic naming of Pier 2/3 results from the sale of the Pier's lease by the Ports Authority, the landowner, some years ago, separately from its Shore Sheds. Thus without its Shore Sheds it is referred to as a 'Pier' rather than a complete Wharf, still-united with its wharf sheds as is Wharf 4/5.



This aerial photo of Walsh Bay shows Pier 1 at left, Pier 2/3 closest to the camera, then Wharf 4/5, Wharf 6/7 and Wharf 8/9 at far right. Beyond the wharves are the approach structures leading to the Harbour Bridge, and the Sydney CBD skyline. Image Source: Infrastructure NSW.

Walsh Bay is intrinsically linked with the history and growth of the surrounding areas of Millers Point and Dawes Point. This central part of Sydney, adjoining its initial township of The Rocks, is of national heritage significance for its social and cultural mix and its historic architecture, and as the site of the first European settlement in Australia. Before 1788, this was Country of the Gadigal people of the Eora nation, and whilst the site itself is too disturbed for archaeological remains from this occupation, contemporary reports confirm its intensive occupation.

Millers Point was always a mixed residential and industrial maritime precinct containing buildings and spaces dating from early 19th century. Dawes Point is a prominent landmark in Sydney Harbour, the site of the southern abutment and Pylons of the Harbour Bridge, and of Dawes Point Battery, a major and early element in Sydney Harbour's nineteenth century defences. It was also the site of colony's first observatory, set up by Lt William Dawes who documented much of the Gadigal language.

The colonial era industry in the area included boating, windmills and quarrying. With the expansion of agriculture and a flourishing import and export industry, trade increased the use of waterfront areas, growing as the wealth from the gold rushes during the 1850s boosted Sydney's economy. As the town grew and trade increased, larger sailing and then steam vessels required the expansion of the privately owned wharves, so that by 1900 there were fourteen finger wharves in Walsh Bay, reaching out to the deep waters.<sup>2</sup>

1 A brief biography of Peter Tonkin can be found at <https://www.daao.org.au/bio/peter-tonkin/biography/>. His firm, Tonkin Zulaikha Greer, was appointed in 2016 to reimagine the Pier 2/3 as performance venues for Bell Shakespeare, the Australian Theatre for Young People (ATYP) and the Australian Chamber Orchestra (ACO), as well as to refurbish Wharf 4/5 (completed in December 2020), which was already home to the Sydney Dance Company (SDC), Gondwanna Choirs and Bangarra Dance Theatre. The firm has won several heritage awards for these works.

2 Graham Brookes and Associates, Wharf 4/5 Walsh Bay, Conservation Management Plan 2007.

## Engineering Heritage of the Walsh Bay Arts Precinct

Unsanitary and makeshift conditions resulted from the small scale private ownership of the wharves during this time, exacerbated by the adjoining conglomeration of overcrowded ‘slum’ dwellings. The outbreak of the Bubonic Plague in 1900 acted as a catalyst for what was a widely-desired reconstruction of the waterfront, providing more efficient shipping and better living conditions for workers.

*In Sydney, as elsewhere, there was a growing belief that the port city demanded a general overhaul. Not only wharves, but warehouses and stores, roads, railways and commercial facilities needed to be integrated and enlarged. The advent of electricity, concrete construction and the petrol engine widened the engineering horizon; the new emphasis on government action and finance gave the opportunity. Discussion in the 1890s gave way to activity in the period after Federation, when the State Government could attend to and spend money on domestic problems.<sup>3</sup>*

In 1901, the NSW Government oversaw the creation of the Sydney Harbour Trust and the resumption of the wharves and the adjoining properties, in a huge arc from Circular Quay to Balmain around Darling Harbour and White Bay.

The first President of the new Trust on its formation was Robert Rowan Purdon Hickson (1842-1923), an Irish port engineer who emigrated in 1876 and joined the NSW Department of Public Works in 1881. Between then and his retirement in 1912 he undertook world-wide study of port development, and sat on the wide ranging 1910 Royal Commission on Sydney Improvement. His Engineer in Chief was Henry Deane Walsh (1853-1921), another Irish civil engineer from the Public Works Department, who had emigrated in 1877. Walsh was assisted by Walter Edward Adams, and both are recognised as innovative, talented engineers. Almost 5 million pounds was spent under his direction, a huge outlay for the colony and one of the largest programs of public works at the time.

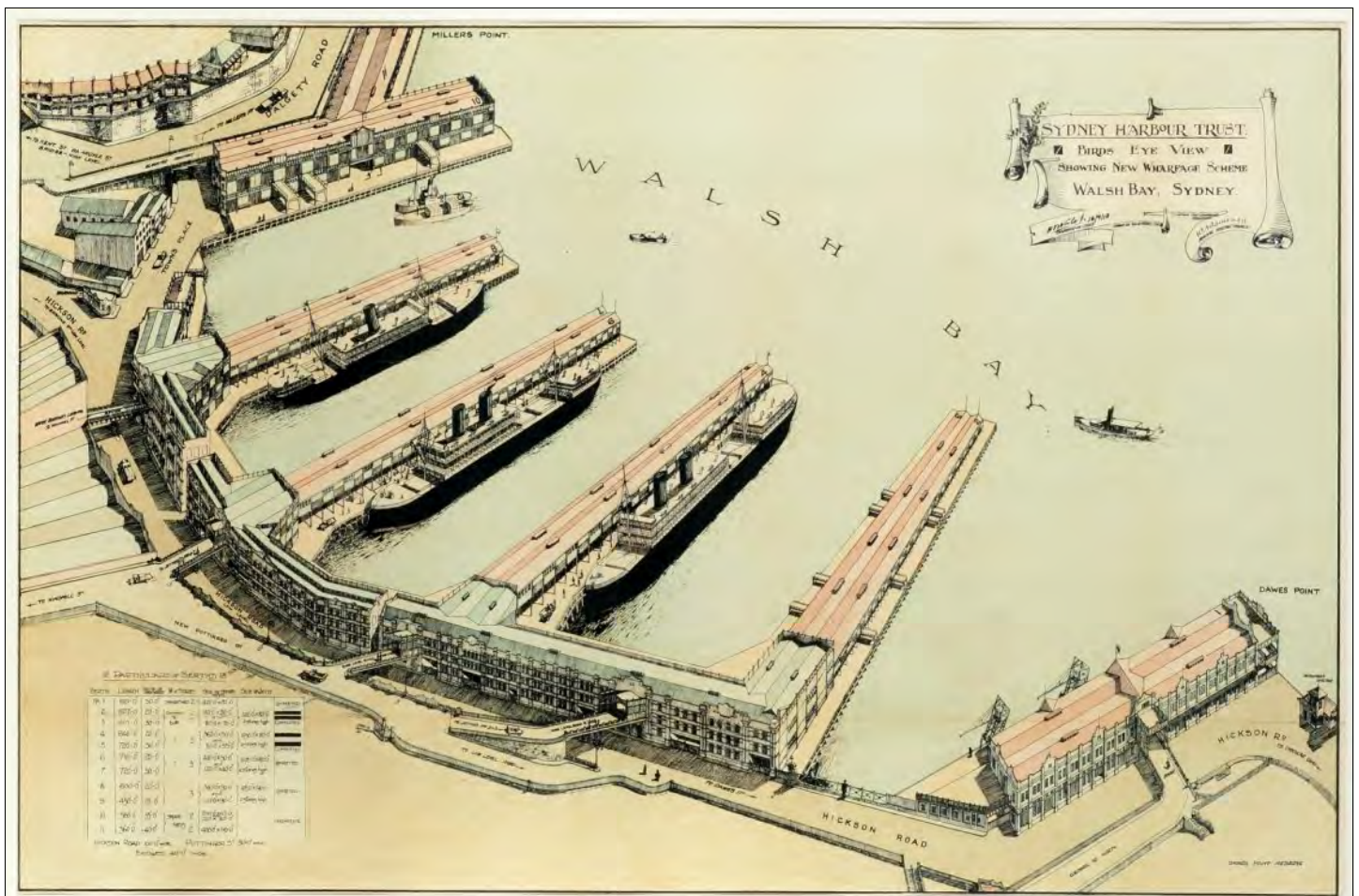

A hand-drawn lithograph with a Bird's Eye View of the Sydney Harbour Trust's "New Wharfage Scheme" for the development of Walsh Bay. Wharf No.1 is on the right, against Dawes Point. Pier 2/3 is next to the left, then Wharves 4/5, 6/7 and 8/9. The buildings shown at Wharves 10/11, at Miller's Point, were never built.

The drawing was made by T.C. Groom, Chief Engineering Draughtsman (of the Trust) and W.H. Withers, and signed by Withers on 12/9/18. Both H.D. Walsh, Engineer-in-Chief of the Sydney Harbour Trust, and W.E. Adams, Principal Assistant Engineer of the Trust, signed the drawing on 16/9.1918.

3 Tropman and Tropman, Heritage and Archaeology Report, for Arts NSW July 2016.

## Engineering Heritage of the Walsh Bay Arts Precinct

The Trust's program is captured in a hand-drawn lithograph, showing the sweep of reconstructed waterfront with its integrated railways and roadworks, making an enormous and efficient goods transfer system for Sydney's great natural harbour, reinforcing its role as Australia's premier port and a key part of the Asia/Pacific trade routes.<sup>4</sup> Undertaken in stages, and never fully realised, the project wound down in the early 1920s. Major elements included split level wharves at Darling Harbour, demolished in the 1970s and 80s for container terminals and now reconstructed as Barangaroo, and the Darling Harbour Goods Rail Line, abandoned in the 1970s as it missed the container wharves. This area was converted to the Darling Harbour precinct for the 1988 Bicentennial.

Another significant part of the Trust's program was the large amount of workers housing, designed to provide advanced sanitary conditions, as duplex apartments often with roof terraces for clothes drying, and with the appearance of terrace houses. These accommodated social housing up to the early 21st century when they were sold off for expensive private housing.

Walsh Bay, as the portion of the development with the deepest harbour water and closest to the shipping lanes, was the focus of the project. Construction of the wharves began with the major cliff excavations in 1909 to form Hickson Road, a broad connector wide enough to turn a bullock dray and to fit a future rail line, but focused on the future of motor vehicles. It was completed in 1921 with the realignment of Pottinger Street, the upper level connection to The Rocks.

Both Pier 2/3 and Wharf 4/5 were constructed in stages from 1912 to 1923, and are similar in overall conception to the other Walsh Bay Wharves: Pier 6/7 was demolished and replaced many years later, with a new apartment building over the water. Pier 8/9, was converted to offices in the late 1990s. Each comprises several levels, accessed separately from Hickson Road and from the streets behind in The Rocks via bridges over the roadway. All the wharves originally had almost continuous Shore Sheds linked directly to the Wharf Sheds, and long jetties on timber piles over deep water.

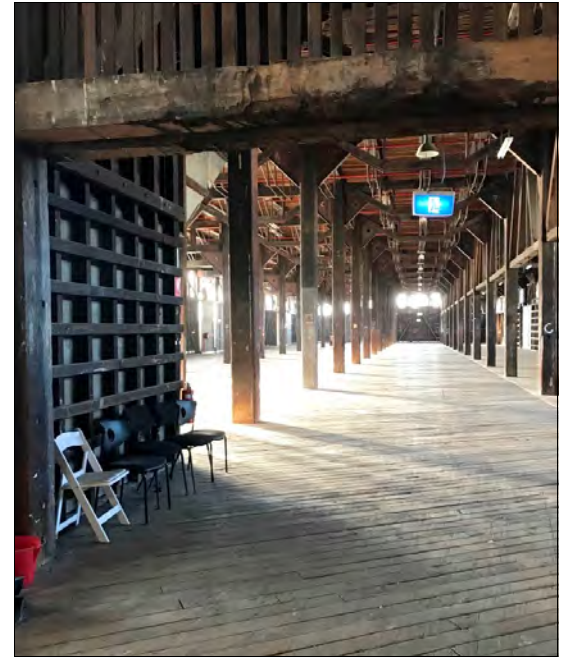

The cavernous empty spaces of Pier 2/3 before the recent Arts Precinct project commenced, showing the original structure intact. Photo: Brett Boardman.

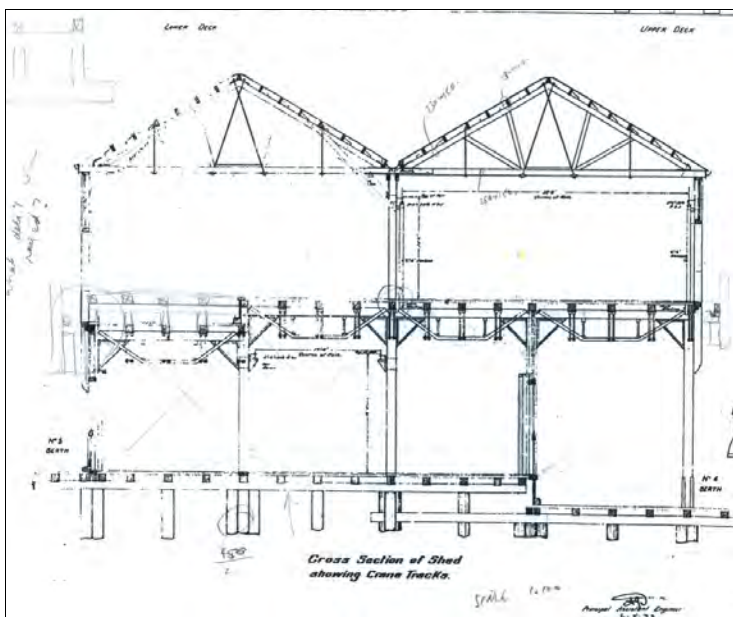

An original section drawing across Pier 2/3 wharf shed, showing the construction of roof and floor framing as it was built, and under the lower floor, the tops of the ironbark piling. Source: Sydney Harbour Trust.

The water depth posed a challenge. Conventional piles for jetty wharves were inadequate. During the late 19th century, Norman Selfe, a highly inventive local engineer, was experimenting with pile technology to overcome the problem, and his system of spliced hardwood piles was used for the jetties at Walsh Bay, where the water depth approaches 30m.<sup>5</sup> The piles were ironbark, and required successive repairs as the timber degraded over time, particularly in the intertidal zone where marine organisms attack the timber.

Walsh used precast concrete sections to create a rat proof sea wall, which runs under the shore sheds, and was backfilled with the spoil from the excavation forming Hickson Road. Along the roadway to the east are massive sandstone retaining walls up to 15m high, and these extend to form terraces allowing the preservation of Victorian era terrace houses lining the streets above.

<sup>4</sup> Sydney Harbour Trust, Bird's Eye View showing new wharfage scheme, Walsh Bay, Sydney, 1918.

<sup>5</sup> Tropman & Tropman, *ibid*.

## Engineering Heritage of the Walsh Bay Arts Precinct

The wharves have early reinforced concrete aprons all round, 12m wide, allowing the circulation of cargo vehicles and the servicing of the berthed ships. The concrete is laid on massive timber beams forming the pile headstocks, and these have survived to the present. The aprons are typically at two levels, allowing a loading level from a truck direct to the wharf shed floor on one side or a level vehicle access on the other. Ramps at the seaward end connect the two levels and allow vehicle circulation all round.

Both the shore and the wharf sheds are constructed of massive timber, possibly due to post-WW1 shortages of steel, which had by the early 20th century replaced the Victorian era use of heavy structural timber. The shore sheds are faced along Hickson Road with elegantly detailed free-style Classical facades in brick and sandstone, creating a suitable civic frontage to the industrial uses behind. They remain lively and elegant, enriching the subtle curve of the roadway as a generous city boulevard.

The wharf sheds are up to 180 metres long and 25 metres wide, each resting on hundreds of timber piles down to the harbour bed. Their simple post and beam timber structures are scaled to the available lengths of the massive timbers used, with a vertical and horizontal module of 20 feet (6.1m), allowing the required clear spans for cargo movement, and the internal height for the stacking of crates or bales. Columns, or storey posts, are 18 inches (450mm) square at 20 foot centres in four bays wide on the lower level, while on the upper level the increased spans possible with the trussed roofs allow an increased span across the width of the sheds of 40 feet.

To support the very heavy loads imposed by the stacked cargo and the vehicles used to transport it, each timber beam is reinforced with a forged steel ‘strongback’, a reversed tension tie which allows a doubling of the load carried with a significant reduction in deflection. The main beams at each column, 350x350mm, have heavy strongbacks approximately 1m

deep, those on the floor joists between, of timber, are smaller and lighter. The joists carry heavy flooring planks spaced apart, with a diagonal layer, 4 inches thick, of ironbark flooring above. The diagonal layout provides cross bracing at the plane of the floor, while rivetted steel plate triangles provide cross bracing vertically. The upper floor was at some stage covered with asphalt, removed in 2020 as part of the adaptation. The timber roof trusses are reinforced by iron ties and turnbuckles, joined by bolted steel plate connections. In Wharf 4/5 the strongbacks were removed as part of the 1980s adaptation — in Pier 2/3, they remain.



The conserved wharf exterior showing the gantry rail and a reconstructed gantry balcony. Photo: Brett Boardman.

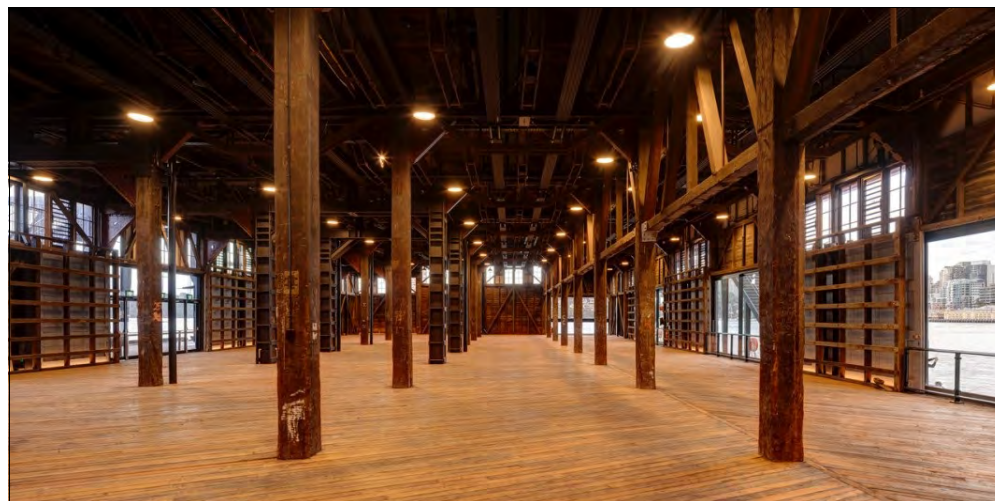

The north (seaward) end of the Pier 2/3 wharf shed has been left close to its original state as a flexible multi-use space. Photo: Brett Boardman.

The facades incorporate a distinctive ‘checkerboard’ pattern based on the modular structure. Large sliding cargo doors alternate with weatherboard infills along their length, with timber framed multi-paned windows and fibre cement panels alternating above.

The roof has paired gables with a very long valley gutter between, drained at several points down to the Harbour. It incorporates multiple lanterns with windows and metal louvres for ventilation and lighting.

## Engineering Heritage of the Walsh Bay Arts Precinct

The wharf shed was originally split level on the upper floor providing a long loading bay the entire length of the east side. Evidence of this split level layout can be seen from the underside floor framing, and the mirroring of the diagonal boarding above.

The Walsh Bay wharves continued in busy operation for cargo shipping throughout the interwar years, and were extensively used for troop movements and supplies during World War 2. After the war, coastal shipping, already in decline, was further reduced, while ships grew larger and required bigger berths. By the 1960s, longshore wharfage was replacing the Hickson-designed finger wharves along Darling Harbour, and the Walsh Bay wharves began a long period of inactivity. The 1970s saw a crucial decision by the Maritime Services Board, the successor to the Sydney Harbour Trust, that Walsh Bay could not be redeveloped as longshore wharves for container vessels.

In 1985, the then Premier of NSW announced the adaptation of the upper level of Wharf 4/5 as the home of the new Sydney Theatre Company, and the reuse of the lower levels for arts companies followed in the 1990s. This use was reinforced with the construction of the Roslyn Packer Theatre for the STC opposite Wharf 4/5, and the redevelopment of the former Darling Harbour container wharves for the new Barangaroo commercial and residential precinct, still underway, and including a new underground metro station.



The shared Foyer at wharf level in Pier 2/3 with new lifts and stairs carefully inserted, and the conserved steel strongbacks. Photo: Brett Boardman.



A lightened detail adapted from Brett Boardman's photo of the Foyer at the wharf level of Pier 2/3, showing the construction of the under floor level above.

years, with Bangarra Dance Theatre, Gondwana Choirs, Sydney Philharmonia Choirs, The Song Company and Sydney Dance Company all located in the lower shed of the structure, and each including production, administration, rehearsal and performance venues. Extensive refurbishment, designed by Tonkin Zulaikha Greer (TZG), was undertaken to reinvigorate these spaces and upgrade them to meet the required technical standards and to accommodate the reconfigured spaces above. This was carried out as a separate project. The new Wharf 4/5 opened in 2021.

Pier 2/3, previously undeveloped, has been transformed (by TZG) to house the Australian Chamber Orchestra, Australian Theatre for Young People and Bell Shakespeare. The facilities include multiple theatres, rehearsal studios, production workshops, function spaces and administrative offices, as well as an acoustically-rich concert chamber.

With each of the wharves similar in volume to a 40 storey timber skyscraper laid on its side over water, the project presented a high level of design and constructional challenge. External modifications to the buildings were minimised, with the most prominent change being the introduction of external balconies and stairs that provide required egress and upper-level breakout spaces. Designed as an interpretation of the original shipping gantries, they are complemented by external glass lifts that minimised internal demolition. Extensive re-piling and timber repair required the sourcing of appropriate hardwood and careful craftsmanship.



## Engineering Heritage of the Walsh Bay Arts Precinct

Internally, in Pier 2/3, the architecture celebrates the original volumes and structure. Massive timber storey posts and trusses are retained, as are the remnant iron and steel ‘strongbacks’. Circulation, event and foyer spaces are left in their ‘raw’ state to enable the textures of the original timber to remain visible.

The performance and rehearsal spaces, which required significant acoustic separation and air conditioning, are pulled away from the single-skin weatherboard facades as separate volumes. Their cladding, in deep bronze anodised aluminium, recalls shipping containers or the original weatherboards. At high level, walls are treated in mirror, giving the appropriately theatrical illusion of the original and eloquent structure continuing beyond.

Environmentally Sustainable Design (ESD) initiatives, integral to the project, include:

- Adaptive re-use and repurposing of original fabric to reduce embodied energy.
- Harbour Heat Rejection system which minimises consumption of energy and water.
- Target 30% reduction of energy demand through a 489kW PV system, passive design and efficient fittings.

Over the project’s long and complex journey, TZG, along with the NSW Government client, the arts companies, technical consultants and the builders, set in place a collaborative approach to ensure a successful outcome for all stakeholders.

There are many stand-out attributes that make the project noteworthy. Here are a few:

- It is the largest adaptive reuse of a heritage building to date in Australia, and one of the largest globally. As such, it demonstrates how our cultural and technical heritage can be conserved and brought into active contemporary use, thus linking the past to the future in a way that is both exciting and responsible.
- The adaptive reuse of Pier 2/3 and Wharf 4/5 at Walsh Bay brings significant heritage and environmental benefits, reducing embodied energy, capturing tonnes of carbon and avoiding waste.
- Importantly, this careful and responsible reuse of historic structures has brought no sacrifice of quality. Each venue has been tailored to the specific functional and acoustic requirements of the users.
- The Precinct provides a wide range of venues, each with its own special character, each a recognisable part of a unique, historic timber structure in an equally unique setting. They include a flat-floor event space for upwards of 1500 guests with panoramic water views on all sides, an intimate 200 seat drama theatre focussed on young people’s performance, a flexible performance/rehearsal space seating up to 400, a suite of voluminous dance studios with natural ventilation, and a concert hall for 350 with acoustics recognised as world-leading that also captures views of Sydney Harbour.
- The various journeys through the building, of back-of-house production and administrative workers, performers, audience, and interested public, bring people into an architectural dialogue with historic industrial construction and contemporary architecture, as well as a close-up engagement with Sydney’s unique harbourfront.

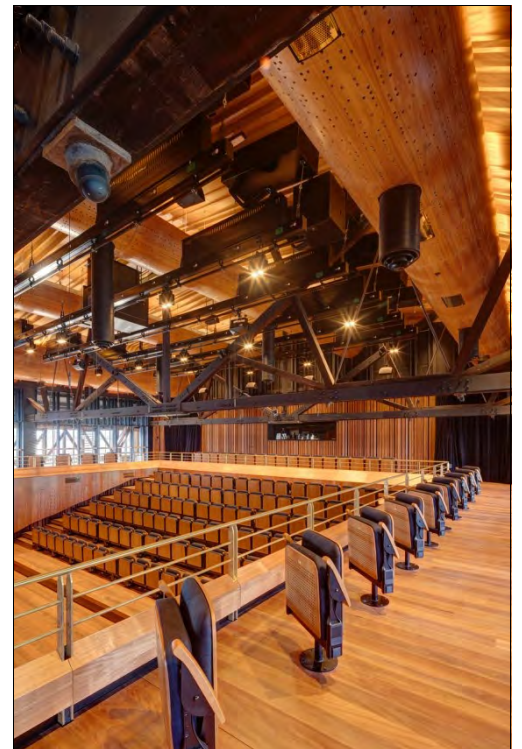

In Pier 2/3, a variety of rehearsal, production and performance spaces are accommodated, each celebrating their location inside the historic timber structures. Photo: Brett Boardman.

---

### *Some more information about Walsh Bay, & images, to explore:*

The SMH, on 20<sup>th</sup> August 2022, tells us how Tonkin Zulaikha Greer *received top honours in this year's New South Wales Architecture Awards, including the Greenway Award for Heritage and the Public Architecture Award.* See:

<https://www.smh.com.au/property/living/theatrical-magic-walsh-bay-s-peerless-renovation-takes-out-top-award-20220818-p5bawc.html>

See ArchitectureAU at: <https://architectureau.com/articles/massive-walsh-bay-arts-precinct-redevelopment-complete/#img-11>

Find tons more stuff if you Google Walsh Bay Arts Precinct, Walsh Bay History, Pier 2/3 & variations thereon.

*The Editor*

# The Amiens Gun

By Geoff Lillico and Bill Phippen

## Capture of the gun

Early in August 1918, in the closing stages of World War 1, the five divisions of the Australian Corps, joined by two Canadian divisions, made a significant advance near Villers-Bretonneux in northern France. About 200 metres beyond the limit of their planned advance near Harbonnières, troops of the 31st Battalion could see a large (11.2 inch) German railway gun, complete as a train with locomotive, ammunition wagons and accommodation cars for the crew. It had been attacked by an airman, setting alight some cars, and British cavalry had over-run it and captured the crew.

Lieutenant George Burrows, an officer attached to the 8th Field Company Engineers which was assigned to the battalion for the attack, went forward with two sappers, Leslie James Strahan and John Henry Palmer.

Their task was to destroy the gun but instead they managed to raise steam on the locomotive, shunted the burning vehicles off the train, and then brought the assembly behind the front lines. This action was done under fire and at one stage the feed pipe from the injector on the locomotive was perforated by a machine gun bullet, but repairs were made with tracing tape.

Palmer's account is recorded on the Australian War Memorial website's description of the gun: *We had been sent with a quantity of Amanol to blow up the large gun ... however Les Strahan one of our sappers in the party had been a driver in the Western Australian railways, and he found there was still a head of steam, he asked for a fair go, instead of blowing the gun up he got the engine going, we were told then to try to get it back if possible into a cutting so it could be camouflaged.*



Lieutenant George Burrows MC and bar, the officer who led the sappers who captured the gun. No.346764 Railway and Tramway Magazine June 1920

George Burrows was a resident of Penrith, New South Wales, and although not himself a NSW railwayman, was the son of a railwayman, the brother of two serving railwaymen and the son-in-law of an engineer in the Signals Branch. The crucial sentence in his account is perhaps: *It was a bit exciting while we were trying to get the gun away. I was all prepared to destroy her if we failed; but all's well that ends well.*<sup>1</sup>

Palmer was a tradesman boilermaker with Queensland Railways before enlistment, so that between the three soldiers there was enough knowledge to repair and drive the foreign machine.<sup>2</sup>

The 8th Field Company of Engineers purpose in being attached to the 31st Battalion was to set up barbed-wire entanglements in front of the new front line and to dig a series of strong points 200 yards behind for reserve companies. The gun was brought back about 600 yards but at that point the track had been damaged by shellfire. Messages were quickly sent for a party to repair the track – and for more water for the engine. The work was completed through the night but when the train moved again in the morning the gun derailed some wheels. The vehicle came equipped with several large jacks which were intended to lift it off its wheels for firing, and these were used to re-rail it. It was quickly moved to Bayonvillers, well safe from any German counter-offensive.

Burrows was, the next month, awarded a bar to his Military Cross for his gallantry in securing the weapon which had been damaging areas well behind the front line for months. Unfortunately, his military record is unavailable, except for a fee. He served in the Second World War as well and his records have been amalgamated into a single packet, but the National Archives of Australia (NAA) hasn't digitised the WWII records yet.



AUSTRALIAN WAR MEMORIAL P01887.001  
The gun in operation with its German crew. According to the Sydney Mail of 26 January 1920 this is a postcard found with the gun at its capture. Photo No.346765 Railway & Tramway Magazine June 1920. AWM No.P01887.001

1 Sydney Mail 26 January 1920

2 NAA:B2455, Palmer John Henry ID 8003987

# The Amiens Gun

Strahan and Palmer were awarded Military Medals in January 1919, presumably for their part in the capture of the gun. Although citations in both the London Gazette and the Commonwealth Government Gazette have been sighted they give no details. Tantalisingly, Strahan's NAA file includes a letter to his mother advising of the award, including the words: *The specific deed for which this decoration was awarded is attached hereto*, but there is no attachment.<sup>3</sup>

The gun was actually a naval gun, originally used on the battleship SMS *Hessen*. The barrel alone weighed 45 tons and the total unit 185 tons, carried on two 5-axle bogies. References to its calibre vary – 28cm, 11 inch, 11.2 inch or 11½ inch. For firing it lowered circular pads onto timber cribs placed on the track to absorb the recoil. The projectile weighed 600 pounds and had a range of 26,000 yards.

The gun was claimed as a trophy by the Australians, though not without dispute as there had been attacks on it by the Royal Air Force, the Australian Flying Corps, tanks, and cavalry had driven off the crew. Ultimately the Australian claim was accepted. Even within the AIF there was quibbling as to the details. Burrows own words, or at least what is set out in quote marks in *The Railway and Tramway Magazine* in May 1920 as his words, tell the story.<sup>4</sup> *There was one amusing incident, in connection with which I had better make the position clear. I was an officer of the 14th Field Company (5th Division), Engineers, and was on loan to the 8th Field Company only for the attack. I was on loan to them when the gun was captured. After the gun had been taken behind our lines the O.C. of the 8th Field Company sent a man up with a pot of white paint, and he painted on the side of the gun in large letters :*

### Captured by the 8th Field Company

*Naturally the seizure of such a big gun – with the bogies it weighed 185 tons – excited some interest. Besides, it was the gun that the Germans had brought up specially to shell Amiens. Well, when the announcement of the 8th Field Company appeared on it the C.O. of the 31st Battalion was not satisfied. As soon as he spotted it he sent along another man with another pot of paint, and the first announcement was painted out, and the new words painted on :*

### Captured by the 31st Battalion

*It was interesting, as well as amusing; but the fact is I was not under the orders of the C.O. of the 31st Battalion, but was under the orders of the O.C. of the 8th Field Company, although really an officer of the 14th Field Company.*

### Shipment to Sydney & exhibition

After exhibition in Paris and shipment to England on a Channel ferry, the gun was examined at Woolwich Arsenal and then loaded at Chatham onto a ship, *Dongarra*, for despatch to Australia. This ship was also a captured German asset, originally named *Stetsenfels*.

Although the 31st Battalion was a Victorian unit and might in other circumstances have wanted the weapon exhibited in Melbourne, the trophy was Commonwealth property and had to go to NSW as that was the only state with the standard gauge tracks to fit its bogies. The Commonwealth Railways were only a year old in 1918 and there was little point in taking the thing to Port Augusta, even if a wharf or crane could be found to unload it.

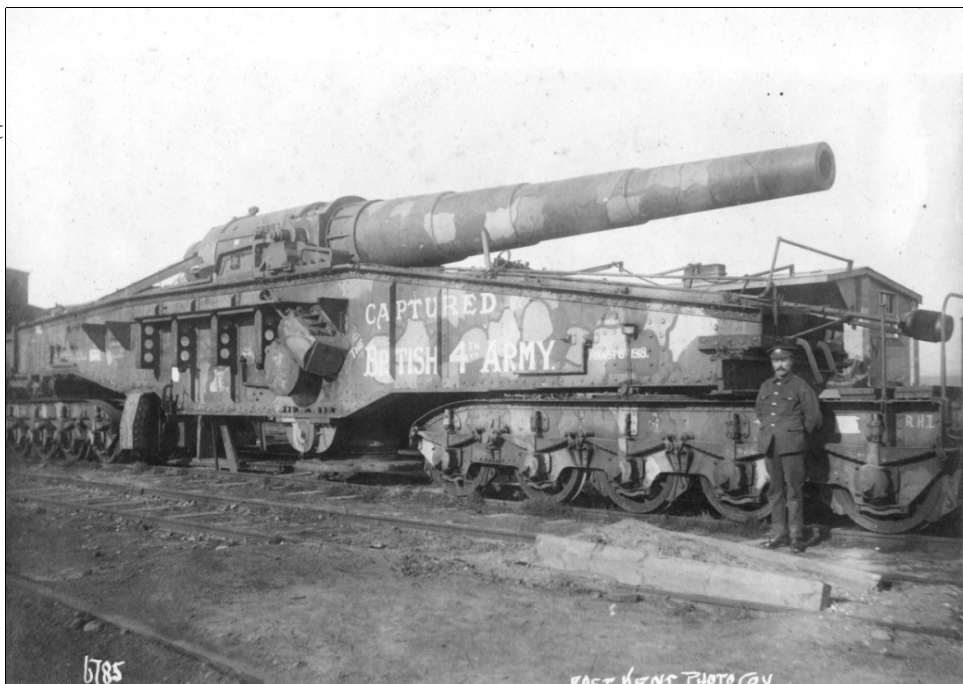

The gun in England prior to shipment to Australia, guarded by a single sentry, probably circa 1919 or 20. Note that the 31<sup>st</sup> Battalion sign claiming the gun for Australia, has been over-painted by another sign – "Captured by the British 4th Army".!  
Photo: East Kent Photo Coy.

3 NAA: B2455, Strahan Leslie James ID 8094433

4 *Sydney Mail* 26 January 1920

## The Amiens Gun

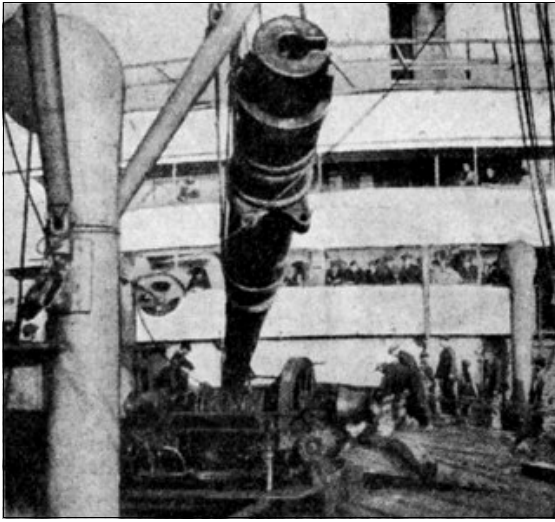

Image at Left:  
The barrel of the gun being loaded onto "Dongarra" at Chatham in England, in 1919. Photo No.346766 From "Railway & Tramway Magazine" June 1920.

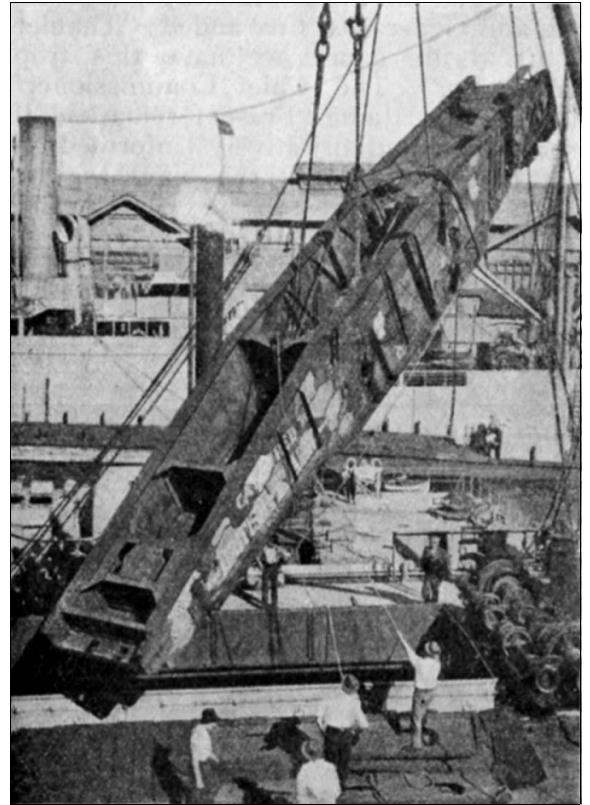

Image at Right:  
The chassis of the gun being unloaded from "Dongarra" at Pymont in 1919. Photo No.346767 From "Railway and Tramway Magazine" June 1920

Later, at the gun's unveiling in Sydney, General Sir C. Rosenthal,<sup>5</sup> alluded to this decision when he:  
*... jocularly remarked that as [the 8th Brigade] was a Victorian Brigade, they would no doubt have kept the great trophy for Victoria, but for the fact that they did not have the proper railway gauge there for it, ...*  
General C Cox added : *Thanks to our 4ft 8 1/2in gauge we have this trophy permanently.*

It should be noted that Rosenthal was incorrect in his description of the 8th Brigade. Although the 31st Battalion, which was one of its components, was Victorian, other sections had been raised all over Australia.

Guillaume Delprat, General Manager of BHP, who was in London in 1919, offered that firm's resources in Newcastle for the unloading and re-assembly. It was realised that the old Hawkesbury River Bridge, between Newcastle and Sydney, could not bear the weight if the gun were moved whole, but since it was shipped in several pieces this was not an overwhelming problem and his offer was accepted.

In fact, the gun was unloaded in Sydney by the floating crane *Titan* in Jones Bay, Pymont, assembled on rail on the wharf, and brought to Eveleigh Workshops where it was prepared for exhibition. *Dongarra* also carried three spare gun barrels for HMAS *Australia* and there was some shuffling back and forth between Pymont and Garden Island during the unloading.

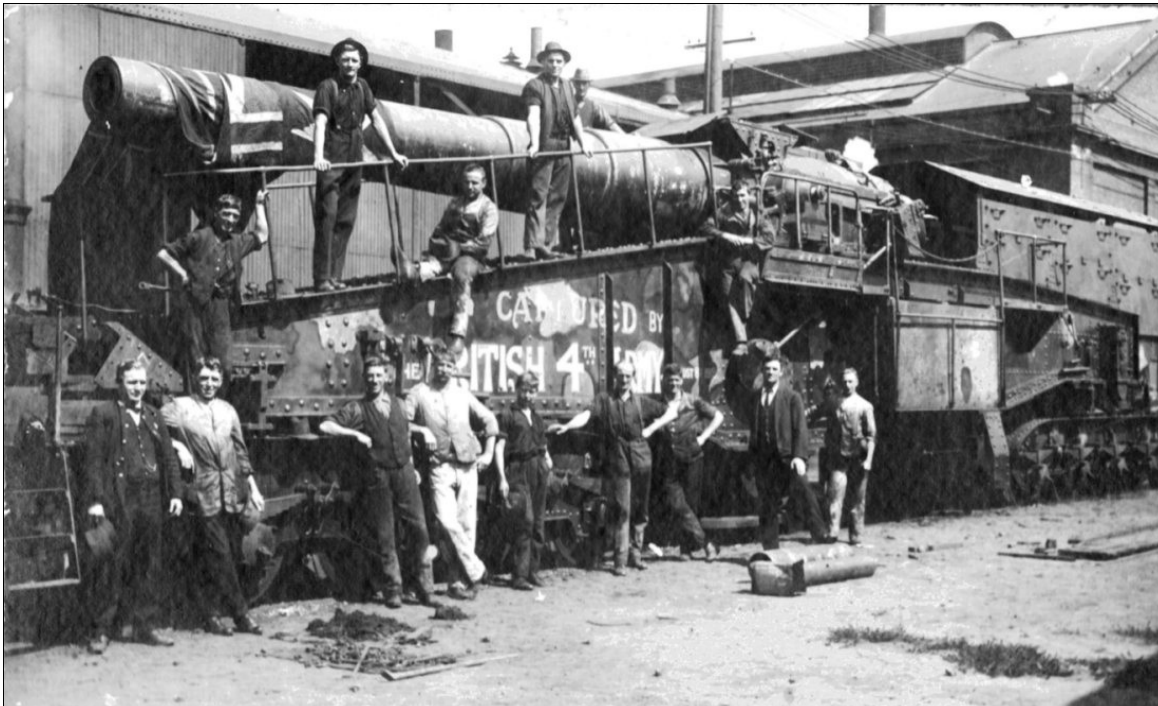

Image at Left:  
The gun at Eveleigh Railway Workshops in Sydney in early 1920. The canopy has been added and a few workers pose with the trophy. Photo No. 047980

<sup>5</sup> *Sydney Mail* 26 January 1920

## The Amiens Gun

At that time the 'electric' platforms at Sydney Central Railway Station did not exist, and a siding extension from Sydney Yard was made to a point which would now be under the City Railway, just beyond platform 22/23 close to the small park at the corner of Elizabeth Street and Eddy Avenue. Here the gun was exhibited from the 26 March 1920. It was floodlit, at least during the visit of the Prince of Wales later in the year.



The gun displayed and floodlit outside Sydney Central Station in 1920, in readiness for a visit by the Prince of Wales. It is on a specially built embankment, alongside Elizabeth Street and opposite Tooheys Brewery.

Source: No.874215 NSW State Archives NRS17420



The obviously subsided gun ran through the end of its siding and derailed. Tarpaulins allow repair work to proceed and may be intended to exclude rain from the weakened embankment. April 1920.

Source: No.874217 NSW State Archives NRS17420

Within a month there were signs of the embankment built to support the new track collapsing under the weight, and the gun was moved back for repairs. But then, on 17 April, the gun rolled forward and overran the dead end and derailed.<sup>6</sup>



Rerailing the gun with jacks and pigsties. April 1920.

Source: No.874218 NSW State Archives NRS17420

## Movement to Canberra

The gun had always been the property of the Commonwealth and intended to be part of the collection of the Australian War Memorial, (AWM) but in 1920 that organisation was in its infancy, without even a site in Canberra for any museum or memorial. The intention of the AWM Committee at the time was for the trophy to remain in a densely populated area - Sydney – where large numbers of people could view it, at least until Federal Parliament relocated to the new capital.

However, by 1922 work on Bradfield's City Railway was underway and the bridge over Eddy Avenue and its approach embankments were about to be built. The siding was extended, and the gun moved forward clear of the work. The gun could be removed easily then for about £280, but once it was hemmed in by retaining walls 8 feet (2.4m) higher than its level, it would have had to be jacked up and a temporary bridge built over the underground station concourse. This was estimated to cost £1000, over and above the cost of the move south.

Reluctantly the AWM Committee agreed that the gun would have to be moved to Canberra, which was always its intended destination, but in 1922 was still a construction site.



The gun is moved forward to clear construction work on the City Railway on 16<sup>th</sup> November 1922. Soon embankments and retaining walls will rise, precluding removal of the gun.

Source: No.874216 NSW State Archives NRS17420

6 *The Sun* 18 April 1920 and other newspapers.

## The Amiens Gun

Initially the move was only going to be to Queanbeyan on the NSW border, as the railway from there to Canberra was owned by the Commonwealth and there was uncertainty about its capacity to carry the weight. In February 1923 the Commonwealth Railways Engineer Way and Works certified that the track was suitable and so the destination became Canberra. In early March the gun was taken to Eveleigh Workshops to be serviced before the trip, which began on 16 May 1923.

The movement was made into an opportunity for the gun to be seen by residents in towns along the way, although the journey was so slow that these stops may have been as much for railway purposes as exhibition. Checking the surviving timetable against distance reveals that the journey was made at 12mph, with an overnight stop in Goulburn.

Of particular concern were two bridges on the route. Although the surviving documents do not identify them specifically, the only reasonable guess must be that these were the laminated timber arch bridges across the Molonglo River at Burbong and the Queanbeyan River near the town of the same name. The New South Wales Railways included in their account for the move the costs of strengthening the bridges. Both were near the end of their lives and would be replaced within two years, and perhaps work was already under way on the project. Certainly, contemporary photos show props under the arches, but it is not known that these were the strengthening required for the passage of the gun in 1923, sensible precautions on an old rotting bridge, or part of the replacement process.



The timber arch bridge at Queanbeyan which was strengthened for the passage of the gun. The props under the centre arch may or may not be the work undertaken but they were erected about the same time. Photo No.1 008145b – Source Possibly NSW State Archives..

The gun arrived safely in Canberra. An estimated total of 2,200 school children viewed the gun enroute. A temporary site for the gun was located in a *position in the vicinity of the Molonglo Camp Railway Siding*. The final costing submitted by the NSW Railway Commissioners to the War Museum Committee, amounted to £402/13/5. In justifying the increase in the charge above the original estimate, the Railway Commissioners cited *unforeseen Permanent Way and Locomotive costs, and £4/13/4 additional freight from Queanbeyan to Canberra*. On 31 May, a letter was forwarded by the War Memorial Committee, via the Commonwealth Railways Secretary, asking him to *thank the New South Wales Railways Department for the efficient manner in which it carried out the removal*. Nearly a week later, on 5 June, the Committee remembered to thank the Commonwealth Railways for their assistance. A little late in the reading of the Press Releases, the *Sydney Daily Telegraph* of 2 June reported that *[the gun] is now proceeding by easy stages to Canberra ... where it will remain permanently. Crowds of country folk have flocked in at various points to see the monster*.

### Molonglo site

The Federal Capital Advisory Committee had agreed to provide a temporary stand for the gun at the loop siding at the *Molonglo Internment Camp*.<sup>7</sup> It is interesting that this site was still referred to in official correspondence by this title. The 'camp' was established in great secrecy when in February 1918 the British Government asked if Australia could provide (at its expense) an internment camp, within 3 months, for about 3,500 German and Austrian nationals being expelled from China, which had declared war on Germany and Austria on 4 August 1917. The last of the detainees were deported to Germany in 1919 at the conclusion of the First World War. Some buildings were sold and removed, whilst those remaining formed the Molonglo Settlement, used by building workers coming to Canberra.<sup>8</sup> At the time of the arrival of the gun, the area would have been correctly described by this title.

<sup>7</sup> Correspondence file National Archives #60976

<sup>8</sup> [http://www.m2cms.com.au/uploaded/18/The Molonglo internment Camp final.pdf](http://www.m2cms.com.au/uploaded/18/The%20Molonglo%20internment%20Camp%20final.pdf)

# The Amiens Gun

The Australian War Museum Committee were anxious to ensure that the site was capable of bearing the weight without any special strengthening and again wrote to the Commonwealth Railways for advice. After a little further exchange of correspondence, it was agreed that the siding was indeed capable of holding the weight. It was arranged that the caretaker at the camp would keep a general watch on the gun. Unfortunately, the platform for the use of the residents of the camp was located on this loop thus prohibiting the mixed train from Queanbeyan from using the platform.

## Molonglo siding

By the end of 1923, the location of the gun was causing concern. Dissatisfaction was expressed by the residents of the Molonglo Settlement as passengers were compelled to clamber into carriages by means of a small step-ladder. Trains stopped on the main line and could not use the platform loop.<sup>9</sup> It was suggested that the gun be moved to the main line, an initiative suggested two months earlier when the line opened for passenger business on 15 October 1923.

## Goods Yard site

The Molonglo platform was closed on 26 March 1924.<sup>10</sup> On 27 June 1924, the gun was moved to a location adjacent to the Canberra Goods Shed where it remained for a further three years.<sup>11</sup> Immediately following the arrival, the question of fencing around the gun arose. The War Museum was described as being anxious *to avoid any unnecessary expenditure owing to straightened finances*, but the Commonwealth Surveyor-General declared *I have no intention of fencing in the gun at the expense of the Home and Territories Department; in fact I am not worrying about it at all*. Consequently, the gun received its fair share of vandalism.

## Railway Station Site

Just prior to the visit of HRH the Duke of York to open Federal Parliament later that month, the Amiens gun, which had stood a grim sentinel on the outskirts of Canberra for some years past, was removed on 4 May 1927 to a new position on a concrete base at the Canberra Railway Station. Its removal necessitated the construction of a spur line of 100 yards and engaged the strenuous efforts for some hours of about 40 men under the direction of Colonel P. Owen, chief engineer to the Federal Capital Commission and the Southern Area Commissioner of the NSWGR, JG Reid.<sup>12</sup> The cost of removal was £500.<sup>13</sup> A programme of tree planting throughout Canberra took place in July 1927 which included a screening adjacent to the gun at the station.<sup>14</sup>

When final construction plans were drawn up for the War Memorial building in 1928, C.E.W. Bean, editor of the *Official History of the War*, confirmed that the gun would be *accommodated in a park near the museum*<sup>15</sup>. In 1935, the gun was repainted and four years later it finally received a light fence to discourage access.<sup>16</sup> The gun remained at the Canberra Railway Station until the outbreak of the Second World War.



The location of the gun (in the red circle) after May 1927, on a small siding at the end of Canberra Railway Station,

Source: Detail from a 1929 City Plan of Canberra.

9 *Daily Telegraph* 7 December 1923

10 *Australian Railway Historical Society Bulletin* November 1967 p246

11 *Canberra's Engineering Heritage* - Canberra Division, Institution of Engineers, Aust. p66

12 *The Canberra Times* 6 May 1927 - p1

13 *Army Journal* Issue No.311 - p10

14 *The Canberra Times* 22 July 1927 - p8

15 *The Argus* 24 March 1928 - p29

16 *Canberra's Engineering Heritage* - Canberra Division, Institution of Engineers, Aust. p66

## The Amiens Gun



Image at Left:  
The Amiens Gun photographed on its siding close to Canberra Railway Station in 1929. It stayed in this location, intact, until September 1942, when it was dismantled.

Source: NAA A3560, 5962, 3174969 2.

### *Big Gun to do a War Job*

Following the outbreak of Second World War, the Army began to display an interest in the gun. A mounting in which heavy gun barrels could be proof-fired after relining was badly needed. The Amiens Gun mounting was seen as the answer, and the Inspector General of Munitions requested a transfer of the gun to their use. It being pointed out to him that the mounting was indispensable to the war effort, the Chairman of the War Memorial Board of Management gave approval to making the equipment available. Arrangements were made to ship it to the Proof and Experimental Establishment at Port Wakefield in South Australia. It was understood by the War Memorial Committee that the parts to be removed would later be returned and the gun reassembled.

### *Disassembly*

In order to effectively dismantle the gun, a short railway line was put down to shunt it to a siding where the special railway crane, which arrived from Sydney on 11 September 1942, was used to accomplish the dismantling of the barrel.<sup>17</sup> The per-way Ganger in charge of the Canberra line reported on that day that he had spent 10 to 14 hours each day of the previous week preparing for the removal of the gun from its resting place to a siding in the Canberra Station Yard in readiness for the transfer to South Australia. A wages bill of £77/11/3 was charged against the costs of the transfer. Additional charges of 3/- for two pick handles and 5/- for extra running of the section car were added to that account! The platform on the gun was *Out of Gauge* and fouled the station platform railings at each end of the platform during removal. A carpenter from the Department of the Interior was requisitioned to make repairs. The cost? – a further £5/5/2. By the time they had assessed all the outgoings, the end result was an account from Commonwealth Railways for £119/11/9.

On 12 September 1942, two 4-wheel wagon loads of various fittings removed from the gun were despatched to the Ordnance Store, Maribyrnong, Victoria. The total weight was 25 tons 6 cwt.<sup>18</sup> The mounting, still resting on its bogies, remained in Loco Road, Canberra Yard with the barrel stored on supports nearby. By 3 August 1943, the stationmaster was beginning to lose patience. He sought assurance from his superiors that the offending vehicle would be moved as its current location was ‘somewhat inconvenient’.

### *Movement to South Australia*

Finally, things began to move. On 20 October 1943, the Director of Rail and Road Transportation advised the NSW Railway Commissioner that the gun mounting would leave Canberra on 27 October. It was scheduled to arrive at Albury on 30 October where the electric cranes in the yard would be used to lift the mounting from its bogies and transfer it to three Victorian Railways flat trucks. Onward movement from Albury was scheduled for 1 November. The Director requested the presence of NSW railway fitters to assist in the *mechanical portion of the transfer operation* and advised that ordnance fitters from the Bandiana Ordnance Depot would be present to assist, if required. It was further stated that it was decided *to store the 4 feet 8 1/2 inches bogies on the New South Wales dead end spur beside No.4 Store at Bandiana Ordnance Depot during the absence of the mounting at Port Wakefield*. He further requested the NSW Railways to make arrangements for the movement of the bogies from Albury to Bandiana.

<sup>17</sup> *The Canberra Times* 11 September 1942 - p3

<sup>18</sup> Commonwealth Railways Consignment Note, National Archives #1664957



## The Amiens Gun

The bogies were, in fact, sent for storage at #1 Central Ordnance Depot at Bandiana. The barrel, the recoil mechanism and other equipment having been removed, the total weight of the mounting and its two five-axle bogies was just 35 tons. However, all was still not smooth running as, on 22 October, advice was given that the movement would not commence until 10 November. But someone must have put some pressure to bear as, on 29 October the movement was brought forward a week.

Following the conclusion of the World War 2 in 1945, the War Memorial made enquiries with the view to having the mounting and bogies returned. The Inspector-General of Munitions in 1948 requested that approval be given by the War Memorial for the retention of the mounting by the Army, on loan, for an indefinite period. The War Memorial Board acceded to the request.<sup>19</sup>

In 1954 the Memorial was advised by the Department of Supply that the mounting was no longer required at Port Wakefield and discussions began as to the ultimate fate of the gun barrel, mountings and bogies. These extended over some years and involved both the ACT Tourist Bureau and the Returned Servicemen's League. At one stage, consideration was given to assembling the complete gun on Mount Pleasant overlooking the Royal Military College, Duntroon.

### Scrapping of the Mounting

Assurances had been given at the time of the disassembly that the mounting would be restored to its original condition at war's end and that all expenditure in connection therewith would be met by the Department of the Army. However, estimates of the cost involved eventually outstripped the will to fulfil these promises. Many years passed. In August 1958 the Australian War Memorial decided to place the barrel in its grounds, then in July 1963, the decision was finally taken to dispose of the mounting. A South Australia scrap metal firm was given the job, with the instruction *You shall mutilate the gun mounting...* It took a week to cut up, and the steel ended up in Japan.<sup>20</sup>

The two bogies at Bandiana were also scrapped at about this time. The barrel and the canopy are now exhibited in the grounds of the Australian War Memorial in Canberra.



The barrel of the former Amiens gun, photographed outside an Australian War Memorial building on 17<sup>th</sup> January 2008. This is all that survives of the Great Gun – a sad display, and a lurid paint job, Source: The AWM website.

---

## Connections

### The Miles Lewis Heritage Building Materials Collection

Here is a fascinating website, with a wealth of information. It should be as useful to engineers involved in heritage conservation as it must be to builders and architects engaged in conservation work. The collection provides an insight into common construction materials and techniques in Australia in the 19<sup>th</sup> and early twentieth centuries. 3D scans of the objects enable exploration of their scale and texture (noticing, for example, the thumbprint in one of the bricks) and trace the European influences on Australian architectural methods. See: [Miles Lewis Heritage Building Materials Collection](https://www.mileslewis.com/) or if that doesn't work try: <https://icomos.us20.list-manage.com/track/click?u=2e555268012b0f81560fcb4e7&id=49b7e6dba1&e=535fc6115d>



---

<sup>19</sup> *Army Journal* Issue No.311 - p11

<sup>20</sup> *Wartime*, Issue No.23 2003 - p9

# Otto Schumacher & his Mill Furnishing Works

By David F. Radcliffe

For over sixty years the distinctive factory of the Schumacher Mill Furnishing Works was a landmark in Port Melbourne.<sup>1</sup> The external facades provided a billboard proudly promoting the many products, systems and engineering services the company offered – flour mills, grain cleaning and grinding machinery, labor saving and elevating machinery, and complete foodstuff plants. The entrepreneurial Otto Schumacher erected this facility in stages over three decades. It incorporated his original factory building with its gable roof erected in 1890.

The factory was located on the edge of the recently reclaimed Sandridge Lagoon. The proximity of the factory to the former lagoon afforded a convenient location for loading machinery and equipment onto wagons ready to transport to customers. The building was in the shadow of a large gasometer – part of the South Melbourne Gasworks. Fortunately, no injuries or serious damage were sustained at the Schumacher works, next door, when, on 4 April 1920, this gasometer collapsed sending a ball of flame into the air as 2 million cubic feet of gas was consumed in a flash.<sup>2</sup>



Schumacher Mill Furnishing Works, Port Melbourne, circa 1940. Source: Museums Victoria Collections. The original gable roofed building is at the right front of the factory, with reclaimed open ground opposite. The big gas holder behind the factory is very close to the Schumacher building!

The origins of Otto Schumacher's very successful business are in mid-west America.

## German-American Immigrant

Born in Osnabrück, Germany in 1858, nine year old Otto Schumacher emigrated with his family to America.



Ferdinand Schumacher's Cascade Mill, Akron, Ohio circa 1878. Source: Cascade Locks Park Association.

They settled in Akron, Ohio, where his uncle Ferdinand Schumacher rose from modest beginnings to become the “Oatmeal King”, a pioneer in popularising cereal as a staple on the breakfast table of Americans.<sup>3</sup> Young Otto apprenticed as a millwright in one of his uncle Ferdinand's mills. Here he became familiar with the roller technology which was revolutionising milling.

Otto moved to San Francisco about 1882 where he was involved in building roller mills. In 1885 he married Lizzie Hudson, daughter of a miller in Salinas, near Monterey in California.<sup>4</sup> A few weeks later, the newly-weds emigrated to Adelaide. They were sponsored by John Dunn, a prominent miller, wheat merchant and philanthropist in South Australia.

1 Completed in 1924, from the mid-1950s until the mid-1980s this building was associated with the name of the new owners Knox-Schlapp.  
2 *Gasometer explodes*, *The Age* (Melbourne), 5 April 1920, p. 5.  
3 Ferdinand Schumacher founded German Mills in 1856, which grew and became one of three companies that merged to become Quaker Oats in 1901. Mark C. Price (2015) *Lost Akron*, *The History Press*, Charleston SC.  
4 While her given names were Elizabeth Victoria, she was always listed as Lizzie – on their marriage record, on the US Federal Census and on newspaper reports about her,

## Otto Schumacher & his Mill Furnishing Works

During the second half of the 19th century, the milling of flour changed from “village” to “merchant milling”.<sup>5</sup> This transition was closely linked to the adoption of new milling technology, centred on a shift from the traditional method of grinding grain using millstones, to crushing it through a series of metal or porcelain rollers. Combined with equipment to perform intermediate processing steps, including the separation of waste, milling became a highly mechanised, semi-automated operation.

Roller milling had been experimented with in Australia, with the first complete system being installed at David Gibson’s mill in Carlton in 1881, using machines from Ganz & Co. of Budapest, Hungary.<sup>6</sup> While this technology had been used for around 40 years in Central Europe, Britain and Australia were much slower to adopt it. In the interim, US millers had recognised the improvement it brought to flour quality and had not only adopted roller milling but had begun to innovate and improve the technology. By the late 1880s, British mills were embracing the roller technology and merchant millers in Australia were rapidly adopting it so they could remain competitive in the world flour market.<sup>7</sup>

### Getting Established

Using the knowledge and expertise of Otto Schumacher, John Dunn & Co began work on the first roller mill in South Australia, in 1885. Erected at Port Augusta, all the machinery for the new mill was imported based on Schumacher’s recommendations and he oversaw the construction of the new mill. While there was very little publicity at the time for the Port Augusta mill, the next project Schumacher worked on began to establish his reputation as a first-class builder of roller mills. At the opening of Dunn’s Ellipse Flour Mill in Port Adelaide in April 1887, Schumacher was described in glowing terms as the “architect, draftsman, engineer and



Peerless Roller Mills, Blumberg, SA, built by Schumacher in 1888  
Source: State Library of South Australia.



millwright” of the new facility and lauded for the quality of his work.

While the major pieces of milling machinery were imported, including the steam engine from England to power the mill, wherever possible local firms were contracted to fabricate ancillary pieces of equipment.<sup>8</sup> Schumacher also supplied roller technology for the John Dunn & Co mill in Port Pirie in 1887.

The next mill Schumacher designed and built was the Peerless Roller Mill erected at Blumberg (now Birdwood) in the Adelaide Hills, for F. Pflaum & Co. His proposal secured the contract over three competing tenders from England, Germany, and America. During the opening in September 1888 it was confidently asserted that “this is the best equipped mill in the colony and possibly Australia”. Eulogised for the excellence of his design and diligence in delivering the project, Schumacher responded that “it was more difficult to reply than to build the mill”.<sup>9</sup>

Image at Left: Milling machinery in Peerless Roller Mill, Blumberg (now Birdwood), SA.  
Source: State Library of South Australia

- 5 W. Lewis Jones, *Where have all the flour mills gone? A history of W.S. Kimpton and Sons - flour millers, 1875-1980*, Melbourne: Flourmillers' Council of Victoria, 1984.
- 6 C.W. Wrigley, S. Tömösközi and F. Békés, *Hungarian-Australian Collaborations in Flour Milling and Test Milling over 120 Years*, Cereal Research Communications, Vol. 39, No. 2 (June 2011), pp. 215-224 and *Flour making by the new process*, The Leader (Melbourne), 19 May 1883, p. 11
- 7 *The Flour Milling Industry*, Advertiser (Adelaide), 22 May, 1893, p. 7.
- 8 *Messrs Dunn and Co's Ellipse Flour Mill, Port Adelaide*, Evening Journal (Adelaide), 9 April, 1887, p. 7.
- 9 *A Magnificent Flour Mill*, Mount Barker Courier and Onkaparinga and Gumeracha Advertiser, 14 September, 1888, p. 3.

## Otto Schumacher & his Mill Furnishing Works

A year earlier (1887), Schumacher had gone into business for himself, erecting a workshop at Kilkenny, Adelaide for the purpose of making flour milling machinery.<sup>10</sup> This enabled him to manufacture some milling equipment as well as effect improvements on the imported machinery for the Blumberg Mill. Schumacher's reputation was such that he next erected a complete mill in 1890 at Northam, northeast of Perth on the edge of the wheat belt. Among the innovations attributed to Schumacher in this mill was the use of galvanised iron rather than wood for the spouting that conveyed grain and flour. In addition to being fire-proof, this approach was more space efficient, leak proof, easy to maintain and reroute.

### Port Melbourne

The Schumacher family moved to Victoria in October 1889, where Otto set about establishing a second manufacturing facility, located in Port Melbourne.<sup>11</sup> From the early 1890s he promoted himself as O.C. Schumacher, builder of flour mills, Port Melbourne and Kilkenny, South Australia. The reasons for the move to Port Melbourne are not known, although it is probable to speculate that the proximity to port facilities, and a larger industrial labour force and manufacturing infrastructure may have contributed to the decision.

Initially, he purchased a single Crown allotment on Esplanade East between Graham and Danks Streets, running through to Johnston Street, and built a small brick factory there.<sup>12</sup> Over the next few years Schumacher acquired additional land on either side of the factory and a blacksmiths shop was added in 1896.

Schumacher continued his well-established practice of looking for ways to improve the design and performance of the machines and equipment he manufactured. This resulted in him being awarded three patents during the 1890s; *Improvements in wheat cleaning machines* jointly with William Reid, a miller in Geelong (1893); *Improvements in roller mills* (1894); *Improvements in cyclones and other similar dust collectors for use in flour mills and the like* (1895).

The business grew and between 1891 & 1909 Schumacher built and furnished or refurbished, in part or in whole, at least thirty mills in WA, SA, Victoria, Qld, Tasmania, NSW and New Zealand. By 1900, he had closed the factory in Kilkenny, as by then the focus of his business operations in South Australia had shifted to selling bicycles, and later, automobiles.

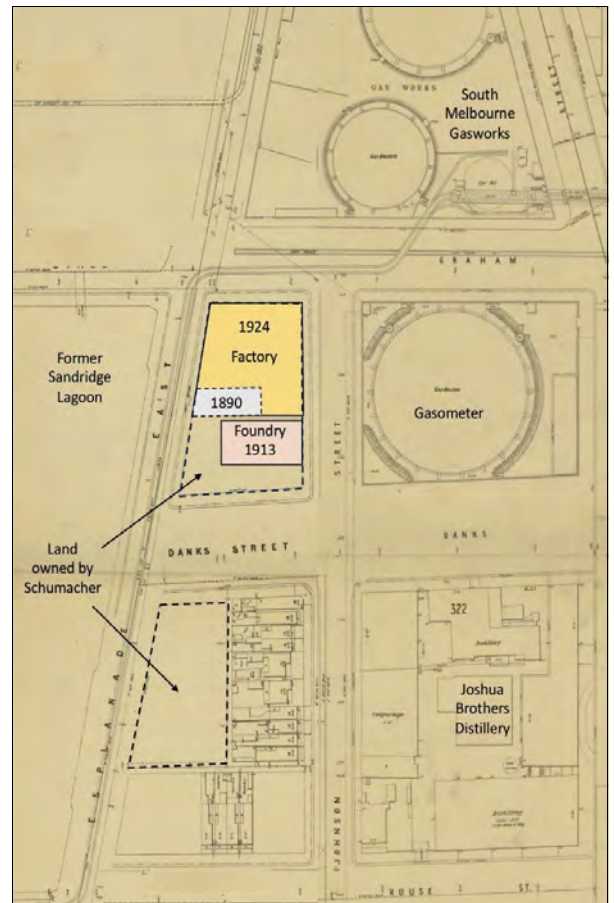

Development of Schumacher Mill Furnishing Works (1890-1924).  
Source: Based on an 1894 MMBW Map.

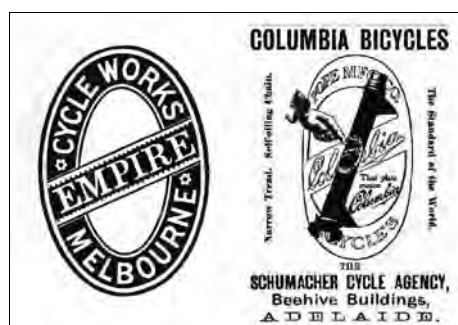

### Cycling and Motoring

With the development in the late 1880s of the 'safety bicycle', with its equal sized wheels, cycling took off in Australia and elsewhere both as a convenient means for personal transportation and as a recreational pursuit.

Otto Schumacher embraced the cycling craze as a business opportunity. He trademarked the name *Empire Cycle Works Melbourne* in June 1896.<sup>13</sup> The local newspaper proudly announced that Schumacher had manufactured his first *Empire* bicycle at his Port Melbourne manufactory and that there was a cycling track for learners.<sup>14</sup> Towards the end of 1896, Otto opened the Schumacher Cycle Agency in Adelaide where they specialised in *Columbia* bicycles.<sup>15</sup> After Schumacher closed his factory in Kilkenny, the branch office for his mill furnishing business was co-located with the Schumacher Cycle Agency. He also opened the Schumacher Cycle Agency in Melbourne in late 1896.

10 On his factory in Port Melbourne, Schumacher listed 1887 as the year his started his business.

11 Schumacher, Otto Charles NAA: A712, 1893/W2058 – Naturalisation.

12 Map No 14, Port Melbourne, Plan 322, Melbourne and Metropolitan Board of Works, 1894.

13 NAA: A11731, 4667 Application for Trade Mark titled *Empire Cycle Works Melbourne* in respect of cycles of all kinds by Otto C Schumacher.

14 *Cycling Standard* (Port Melbourne), 23 May 1896, p. 3.

15 *Cycling Notes, Quiz and the Lantern* (Adelaide), 5 November 1896, p. 5.

## Otto Schumacher & his Mill Furnishing Works

Schumacher's brief foray into bicycle manufacture ended in August 1901 when he sold the *Empire* trademark and manufacturing rights to C.B. Kellow, a prominent bicycle importer, manufacturer, and retailer in Melbourne. Whereas in the 1880s and 90s, people with an adventurous spirit and the money might purchase a bicycle, by 1900 the new "must have" personal mobility technology was the automobile. However, at ten to fifteen times the price of a bicycle, car ownership was much more exclusive. Schumacher shifted his attention to automobiles.

He was one of the fifty-five founding members of the Automobile Club of Victoria, formed in December 1903.<sup>16</sup> In February 1904, he took part in the inaugural club run where about thirty autos motored from Princes Bridge, down St Kilda Road, through East Brighton, Cheltenham and Mordialloc to Aspendale Park (about 35 km through Melbourne suburbs). He also joined the Easter Tour in April 1904.<sup>17</sup>

By 1906, his shopfront in Adelaide had become the Schumacher Cycle and Motor Agency with exclusive rights in Australia for Humber and Siddeley motor cars. After building a new workshop and show room on Victoria Square, Adelaide, Schumacher sold the agency to a local businessman in 1909.<sup>18</sup>



Advertisement of Schumacher Cycle and Motor Agency in Adelaide (1908) Source: Critic (Adelaide).

### Australian Made

In the political tussle between protectionists and free trade advocates, Schumacher came down firmly on the side of tariff protection for local manufacturers. As a member of the Council of the Victorian Chamber of Manufacturers, Schumacher made deputations to the Tariff Commission in 1905 and 1906, leading up to the revision of tariff levels that came into effect in 1908. He told the Commission that under the pre-Federation Victoria tariff he had employed fifty millwrights or engineers at the Port Melbourne works, this number had now dropped to just ten.<sup>19</sup> He felt that if the tariff was not increased significantly, he would have to cease local manufacture putting local people out of work and either close his business or simply become an importer of foreign made machinery.



Schumacher Diagonal Roller Mill (1939).

Source: Museums Victoria Collections.

Schumacher suggested a duty of 35% be placed on flour and oatmeal milling machinery including roller mills, flour dressing machines, flour purifying machines, wheat cleaning machines, grinding mills, and elevating and conveying machinery.<sup>20</sup> He cited three reasons why his firm could not compete with imported milling machinery: the prejudice against local manufactures; the higher wages and shorter working hours in Australia and; the higher tariff on raw materials than on finished goods.

Of course, being both a manufacturer and an importer, tariffs were a complex issue for Schumacher, something of a double-edged sword. He wanted the duty to be low on imported materials and components used in the machinery he manufactured but high on competitor machines and equipment from overseas. When he was starting out in South Australia, Schumacher imported all the milling machines and much of the ancillary equipment in the mills he furnished. Over the subsequent twenty years, his view on tariffs evolved as he became increasingly invested in making the bulk of the machinery in his factory.

<sup>16</sup> *Motoring*, Herald (Melbourne, Vic), 10 December 1903, p. 4.

<sup>17</sup> *Automobile Club*, The Age (Melbourne) 22 February 1904, p.6.

<sup>18</sup> Given Otto Schumacher's early involvement with automobiles, it is worth noting that the National Motor Museum is housed at the former Birdwood Mill which he built.

<sup>19</sup> *Tariff Commission*, Geelong Advertiser, 2 February 1906, p. 4.

<sup>20</sup> *Milling and Leather Machinery*, Daily Telegraph (Launceston), 6 February, p. 6. (No year provided)

## Otto Schumacher & his Mill Furnishing Works

While tariffs generally rose during the interwar period, this position had to be defended. For example, in 1934, the Australian Association of British Manufacturers requested that the Tariff Board reclassify milling machinery on its current schedule which would have the effect of reducing the duty. To counter this, Schumacher's son, Ferdinand, now the company secretary, provided the Tariff Board with confidential financial information on all the mills built or remodelled by the Schumacher Mill Furnishing Works.

### Diversification

From the early 1900s, Schumacher began to diversify the range of products they made and services they offered. This may have been motivated by the tariff issue, saturation in the market to update mills with roller technology, or other factors. A patent awarded to Schumacher in 1906 for *An improved machine for automatically measuring oatmeal, bird seed and other materials and delivering it into packages*, illustrates a shift in thinking.<sup>21</sup> This simple machine not only moved the company into supplying equipment associated with the downstream processing of the output of mills but also opened-up opportunities in any number of industry sectors where powdered or granular materials were metered out and packaged.

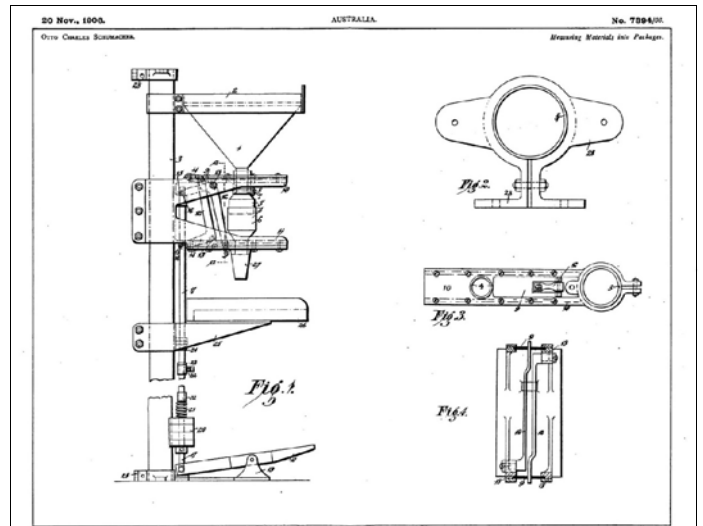

Improved machine for automatically measuring oatmeal, bird seed etc. (1906)  
Source: Australian Patent No. 7394/06

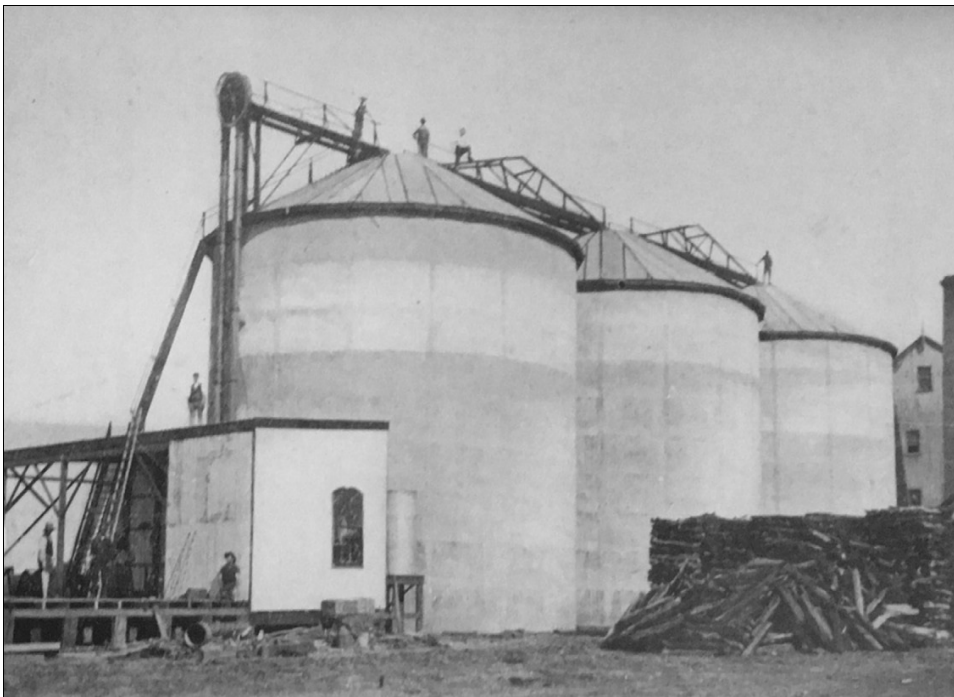

Grain silos designed by John Monash and erected by Schumacher at the Wimmera Flour Milling Company (1908).

Source: Schumacher Grain Cleaning Machinery Catalogue.

Schumacher also moved laterally from just making flour milling plants to erecting storage facilities adjacent to mills. In 1908, he built what is believed to be the first reinforced concrete grain silos in Victoria, and possibly Australia.<sup>22</sup> Designed by John Monash, these four storey high silos at the Wimmera Flour Milling Company at Rupanyup dramatically reduced handling costs and wastage associated with the traditional method of stacking bags of grain at a mill. Reinforced concrete, a relatively new construction material in Australia at the time, enabled much larger silos to be built compared with those made of galvanised iron, with the added advantage of being damp-proof, fire-proof and vermin proof.

Schumacher's business was incorporated as the *Schumacher Mill Furnishing Works Pty.Ltd.* in 1910. During this decade, innovation in both products and processes continued apace. In 1913, they expanded their foundry by introducing crucible steel production. Housed in a new larger building on the southern side of the original factory, this facility gave the firm the ability to produce a wide range of components in-house for the increasingly large number of products they were making. In 1915, Schumacher was awarded a patent for *Improvements in the separation of granular substances*. This innovation was the basis for the seed grading and cleaning machine they introduced the following year.

21 Schumacher, O.C. (1906) *An improved machine for automatically measuring oatmeal, bird seed and other materials and delivering it into packages*. Australian Patent 7394/06, Department of Patents, Commonwealth of Australia.

22 *Four Thousand Ton Silos*, Farmer and Settler (Sydney), 11 September 1908, p. 10.

## Otto Schumacher & his Mill Furnishing Works

The Schumacher Mill Furnishing Works was a prolific promoter of its products and the services they offered, especially in the years following the end of World War 1. The company also produced a series of product catalogues which illustrate the broadening scope of their offerings. These catalogues were richly illustrated with professionally taken photographs of each type of equipment, with accompanying text that gave detailed descriptions of the function, applications, and operation of each.<sup>23</sup>

### From Mill Furnishing to Factory Fitout

While Schumacher continued to make machinery for flour mills and supplied whole plants for making self-raising flour, he also adapted these for use in oatmeal mills and sugar mills, and for maltsters and brewers. The business also began to make machinery for grinding, sifting, mixing, packing, elevating, and conveying that had application across a diverse range of industries. The emphasis remained on providing complete plants for customers.



Advertisement for Schumacher seed grading machine (1918)  
Source: The Bulletin magazine (Trove).

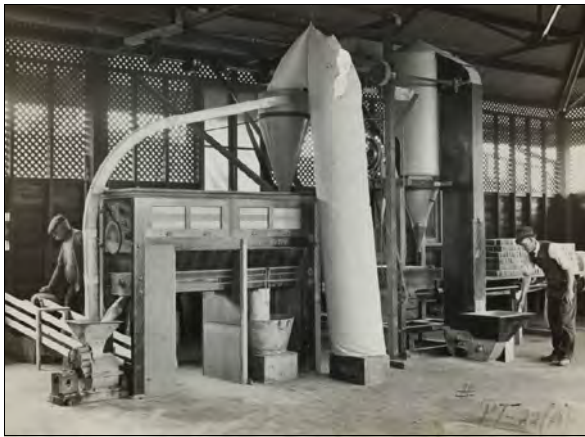

Meat Grinding plant being tested (c 1920s)  
Source: Museums Victoria.

When developing machinery for a new industry sector, they often drew upon the operating principles and/or technologies at the core of their mill furnishing product line and expertise. They imported standard items such as electric motors and worm gearboxes from original equipment manufacturers, and where necessary, highly specialised machines – for example, a sack filling station with an automated sewing machine. Such elements were then incorporated within an overall system they designed and built for a particular application.

Their ball bearing roller conveyor systems were used in butter factories, wholesale grocers, confectioners, bottle manufacturers and merchants, shipping companies, laundries, fruit packing sheds, orchardists, cement manufacturers, dairies, tile and brick makers, boot making factories, cordial makers and even in newspaper

production. These systems included an automatic tallying device to record the number of articles passing along the conveyor.<sup>24</sup> They used the expanse of their factory to prototype and test complete layouts for customers.

Progressively, the company developed specialized powered conveyor belts and chain driven elevators for sacks, cartons, barrels, and suchlike. Their portable inclined belt conveyor was adapted to suit builders, contractors, and road makers, and was capable of handling coal, coke, ashes, earth, and similar materials. They even made a trench digger based on their inclined belt conveyor technology.

But even as their business shifted its focus to materials handling and processing in factories, Schumacher continued to supply equipment to farmers. The basic seed grader was developed into an integrated cleaner, grader, dry pickler and bagger. They made a gravity roller conveyor for moving sacks of chaff on farms and a conveyor belt entry ramp for sheep dips.<sup>25</sup> For farms and factories, they supplied augers for conveying granular materials horizontally, or elevating them up a slope, and bucket elevators for vertical rises.

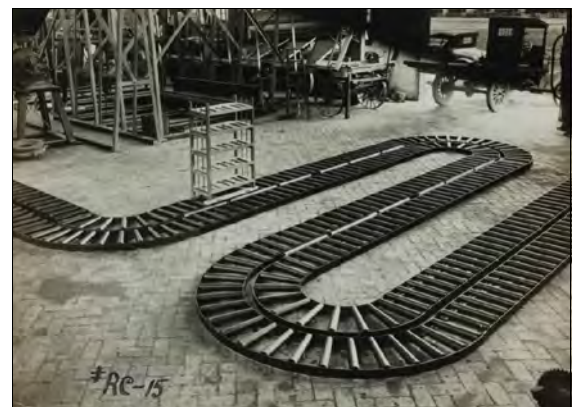

A Roller conveyor layout being prototyped in the Schumacher factory in 1925.  
Source: Museums Victoria Collections.

23 From the 1920s to the 1940s Schumacher used Kerr Brothers Studio, commercial photographers, in Collins St. Melbourne.

24 *Mill Furnishing Works*, Herald (Melbourne), 22 July 1930, p. 30.

25 *Just what sheep farmer have been looking for*, Land (Sydney), 13 December 1929, p. 11.

## Otto Schumacher & his Mill Furnishing Works



Seed cleaner, grader, and bagger ready for delivery during the 1920s. This rig may have been photographed on the open, reclaimed land opposite the factory.

Source: Museums Victoria Collections.

The wide variety of products they developed through the depression years of the 1930s may have reflected the need to be adaptable and supply whatever type of equipment that was in demand. Two of the more unusual examples were a complete blood and bone fertilizer plant (1937),<sup>27</sup> and a 4-ton travelling crane (1938). During the Second World War, Schumacher won numerous government tenders to provide gravity roller conveyors to the Departments of Army, Munitions and Supply while continuing to promote their seed grader and other agricultural equipment in the rural press.

Schumacher grinding, sifting, and mixing equipment was used in food processing plants and industrial facilities. They provided a belt driven grinding plant to the munitions factory in Maribyrnong.<sup>26</sup> Related to this side of the business, the last patent awarded to the firm was in 1927 for *Improvements in and relating to mechanically operated sieves, riddles, and the like*, basically a new mechanism to vibrate a sieve without using an eccentric. However, unlike earlier patents it was registered in the name of the company rather than Otto Schumacher as the inventor.



Workers on a production line in the Schumacher Port Melbourne factory in the 1930s.

Source: Museums Victoria Collections.

### The Death of Otto Schumacher

Otto Schumacher passed away at the age of 87 in January 1946. In addition to Schumacher Mill Furnishing Works Pty Ltd, he had a stake in H. Hudson & Co., maltsters, founded by his brother-in-law, and Schumacher Investments Pty Ltd. While most of his estate, valued at £140,950, went to his widow and extended family members in America, nearly one fifth was invested as the Otto C and Elizabeth Schumacher Trust. Annual returns from this Trust supported a wide range of charities, in particular orphanages and hospitals.<sup>28</sup>

The Schumacher's only child, Ferdinand, aged just 56, passed away eight months after his father. Schumacher Mill Furnishing Works continued trading until July 1950 when the shareholders decided to voluntarily wind-up the company. All the assets were liquidated and the Port Melbourne buildings were purchased by the engineering firm Knox-Schlapp in 1955.<sup>29</sup> The factory was demolished in 1985 to make way for social housing.

### Acknowledgements

The author wishes to thank Graham Engineering Company Pty Ltd for preserving a large collection of photographs from the Otto Schumacher Mill Furnishing Works and donating these to Museums Victoria, and to Museums Victoria for curating this irreplaceable historical record. Thanks are also due to the Cascade Locks Park Association, Ohio.



<sup>26</sup> Commonwealth of Australia Gazette, 21 August 1930 (No.74), p. 1739.

<sup>27</sup> *Blood and bone*, Weekly Times (Melbourne), 27 March 1937, p. 19.

<sup>28</sup> *Charities benefit from £140,950 estate*, Argus (Melbourne), 16 August 1946, p. 18.

<sup>29</sup> *Factory sells for £47,000*, Argus (Melbourne), 18 November 1955, p. 20.



# Portable Engineering

By Prof. Miles Lewis, AM, FAHA.

There is a current proposal to obtain UNESCO World Heritage listing for all the surviving 'portable' [prefabricated] buildings brought to Australia in the nineteenth century. The basis for this is that many more such buildings came to the Australian colonies than to anywhere else in the world, and over a hundred of them survive. They are full of historical interest because of their use in the first European settlements at Perth and Adelaide, and their links with the gold rushes in California and Australia, the Crimean War and other historical developments. They are also full of technical interest because they include early experiments in panelisation, mass production and system building, a variety of patent methods of assembly, and the employment not only of timber and iron, but of many other materials ranging from slate to zinc.

Among these buildings are a number which are of engineering significance, such as lighthouses, reservoirs and gasworks. There are also a number of conventional buildings which exhibit structural developments such as the Polonceau truss, and there are building systems derived from flour mill construction and from railway rolling stock. However bridges, although commonly prefabricated to a considerable degree, have had to be excluded from this account.

The lighthouses include the work of Alexander Gordon (1802-68), who invented the solid trunk lighthouse, and built them in Jamaica, Bermuda, Ceylon [Sri Lanka] the Falklands and elsewhere, but was never able to build one in the British Isles because of the opposition of the Stevenson family.

Gordon's lighthouse consisted of a solid trunk in the form of a frustum of a cone, built up out of cast iron plates. Where exposed directly to the sea, the rival openwork lighthouse had the advantage of offering minimum resistance to the waves, and the critical requirements of that design were the anchorage, the strength of the main members, and the adequacy of the bracing.

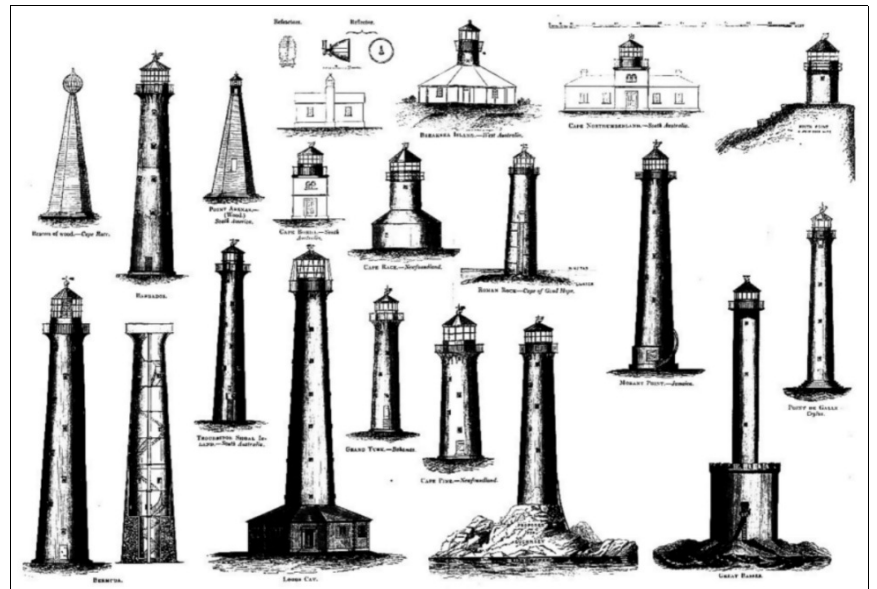

Drawing showing some of Alexander Gordon's lighthouses – from Alexander Gordon, "Circular relating to Lighthouses, Lightships, Buoys, and Beacons." (London 1863), p 45



Gordon's iron trunk lighthouses, by contrast, were not unlike the traditional masonry ones, and relied largely upon weight. The weight of the cast iron shell was substantial in itself, and it was common to augment this by filling the lower levels with masonry or concrete.

Gordon's lighthouses were considered in Victoria and New South Wales but adopted only in South Australia and Western Australia. The components of the Troubridge Shoal lighthouse, in South Australia, were cast by W. Joyce & Co of Greenwich and arrived on the ship *Wynaud* at the end of 1854.<sup>1</sup> It was erected under the supervision of Gordon's agent, Robert Hyndman, and the lantern and optical apparatus were made by Deville & Co. of London. The light was first displayed in December 1855.<sup>2</sup> Upon completion of the lighthouse Hyndman took up the position of Assistant Colonial Architect in South Australia.<sup>3</sup>

Image at left: Troubridge Island lighthouse South Australia, by Alexander Gordon, supervised by Robert Hyndman, 1853-5., lantern replaced c 1930: Photo: Dave Wilde, 2008.

1 *South Australian Register*, 1 December 1854, p 2.

2 *ibid.*, 4 December 1855; 24 December 1855; 1 April 1856.

3 Gordon Reid, *From Dusk Till Dawn: a History of Australian Lighthouses*, (Macmillan Australia, South Melbourne 1988), p 56.

## Portable Engineering

Two atypical Gordon lighthouses, more resembling conventional buildings, were those at Cape Borda and Cape Northumberland, both in South Australia. The government schooner carrying the Cape Northumberland lighthouse was wrecked at Rivoli Bay in August 1858,<sup>4</sup> but the components must have been salvaged, as there is no reference to any replacement. In 1857 H.H. Browne of the Lighthouse Commission, Victoria, recommended that an iron tower lighthouse of the Gordon type carrying a revolving light should be obtained for Gabo Island, off the south-east coast.<sup>5</sup> But this did not eventuate, and the present stone (syenite) tower was built soon afterwards.

The lighthouse at Breaksea Island, King George's Sound, Western Australia, was of the Gordon type, built under the aegis of the Board of Trade, London, and designed by Gordon in his new capacity as Colonial Lighthouse Engineer attached to the Board.<sup>6</sup> It was again prefabricated by W. Joyce & Co. In May 1857 Captain Wray of the Royal Engineers and a party of miners and convicts arrived from Perth to build it, and it was completed the following year.<sup>7</sup> In the 'Notices to Mariners' it was referred to as octagonal,<sup>8</sup> but it was in fact a round tower with octagonal quarters surrounding the base, the remains of which survive, adjoining the lighthouse of 1895 which replaced it.<sup>9</sup>

In 1865 the South Australian government sought designs and prices for a Port Adelaide lighthouse to be placed at the entrance of the Port River, and their Agent-General in London, G.S. Walters, approached Alexander Gordon, now Lighthouse Engineer to the Board of Trade.<sup>10</sup> Gordon proposed something quite unlike his solid trunk type – an iron tube, the submarine part of which was filled with concrete, with the short projecting portion surrounded by a platform.<sup>11</sup>

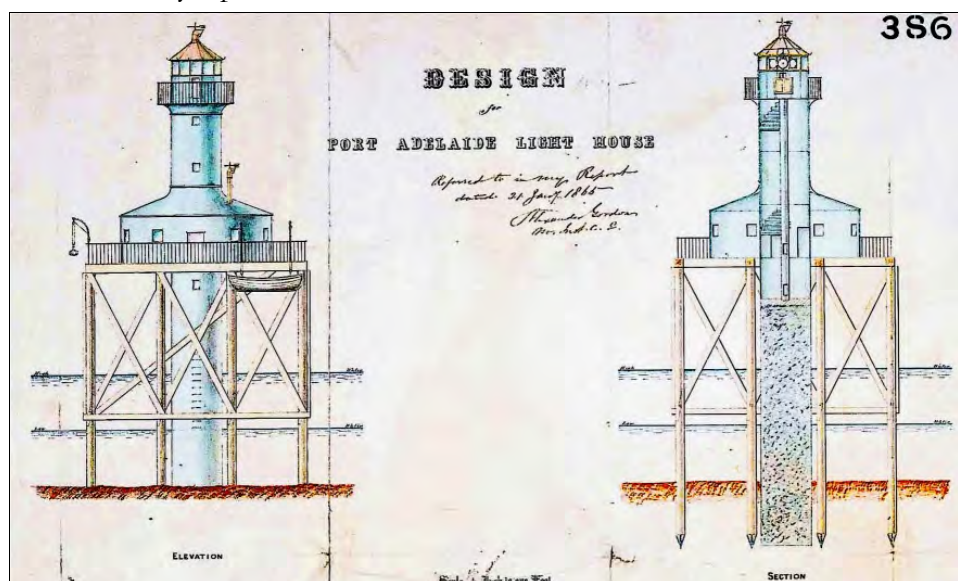

Image Above: Detail from Port Adelaide Lighthouse, designed by Alexander Gordon, fabricated by Richard Moreland & Sons of London 1865-9, elevation & section. Source: NAA A9568 4/1/2.

Image Far Right: Iron lighthouse, Port Adelaide, designed by Alexander Gordon, manufactured by Richard Moreland & Son, London, 1867-70, extended 1875, and moved to the present site in recent times. Photo: Miles Lewis

4 *Star* [Ballarat]. 31 August 1858, p. 2.

5 Victoria, Parliament, *Lighthouses (In continuation of Papers presented on the 19th December, 1856)*, (Government Printer, Melbourne 1857), pp. 3-5.

6 J H S Le Page, *Building a State: the Story of the Public Works Department of Western Australia 1829-1985*, (Water Authority of Western Australia, Leederville [Western Australia] 1984), p. 145.

7 John Ibbotson, *Lighthouses of Australia: Images from the end of an Era*, (Australian Lighthouse Traders Surrey Hills [Victoria], 2001), pp 188-9. Also *From Dusk till Dawn*, by Gordon Reid, pp 60-1.

8 *Argus* (Melbourne), 17 March 1858; *Hobart Town Mercury*, 20 March 1858; *South Australian Register* (Adelaide), 26 March 1858; *Cornwall Chronicle* (Launceston), 31 March 1858, as advised by Peter Marquis-Kyle.

9 Gordon Reid, *From Dusk Till Dawn: a History of Australian Lighthouses* (Macmillan Australia, South Melbourne 1988), p 62; Considine & Griffiths, *Breaksea Island, Western Australia* (Considine & Griffiths, Subiaco [Western Australia] 2000), passim. Although both Reid and Considine & Griffiths refer to it as a stone lighthouse, Peter Marquis-Kyle advised me in 2013 that it was of concrete.

10 O.A. Babbage in the *South Australian Register*, 21 February 1866, p.2.

11 The two sheets, endorsed 'Referred to in my Report dated 21 January 1865' are held by the Federal Department of Transport and are reproduced [albeit illegibly] in Ingrid Anderson, Joan Kerr & Catherine Peake, *Designing Lights: Drawings for Colonial Lighthouses, 1817-1899* [exhibition catalogue] (Federal Department of Transport, Sydney 1988), Nos. 16 & 17. See also Reid, *From Dusk till Dawn*, pp 168-9, though here the original form and the remodelling are confused.

## Portable Engineering

The platform was to be carried on conventional wooden piles shod with iron, as Gordon was reportedly an opponent of the screw pile. George Wells, who now held the rights to Mitchell's screw piles (though the patent itself must have been long expired), heard that a lighthouse was required at Port Adelaide, and requested permission to send in a design, which the Agent-General somewhat grudgingly agreed to forward to Adelaide.<sup>12</sup>

What followed is astonishing. The Agent-General sent out, together, the plans and specifications for the two proposals, but that of George Wells was subsequently 'lost', never to be found again, and Gordon's proposal was the only one to come before the Marine Board. This did not pass unchallenged. Percy Wells, George's brother, was in Adelaide, and formed a partnership with Edmund Wright. Wright & Wells wrote back to England for replacement documents, and (according to their account) obtained an undertaking from the Commissioner of Public Works that no decision would be made in the meantime. However a few months later there was a change in the ministry, after which an order was put in for the lighthouse as recommended by Gordon. Wright & Wells were notified of this only a day after a letter announcing the Gordon lighthouse had been ordered had gone.<sup>13</sup>

The ironwork for the Port Adelaide Lighthouse was manufactured by Richard Moreland & Son of London,<sup>14</sup> and construction began when the components arrived from England in 1867. As described:

*It is one on Mr. Alexander Gordon's principle, the main portion being composed of a cylinder of wrought-iron sunk down to the limestone rock, and filled to about 15 feet [4.5 m] above high-water mark with cement concrete. This cylinder is continued to the height of 79 feet [24m] in cast-iron, and at the top will be placed the lantern which was ordered for Point Marsden. The lighthouse-keeper's quarters are to be erected on a stage of 50 feet [15 m] square, 40 feet [12 m] above the level at high water, and supported by piles of jarrah timber screwed into the limestone rock through 18 feet of sand. The whole will be bolted and braced firmly with cast-iron shoes and sockets, so as to render the whole structure secure and proof against sea and weather.<sup>15</sup>*

It was lit in January 1869, but there were immediate complaints about the poor visibility of the light, and the tower was substantially rebuilt in 1874-5. It was considerably increased in height and the light changed from fifth order to first class, necessitating a considerable increase in the diameter of the tower, which was achieved by adding a flared top. To support what would now be a spindly, top-heavy structure it was surrounded by a structure of iron pillars and diagonal braces,<sup>16</sup> fortuitously giving it much the appearance of a conventional openwork lighthouse in the tradition of Carysfort Reef, USA.



Iron Lighthouse, Port Adelaide, interior detail.  
Photo: Miles Lewis



Iron Lighthouse Port Adelaide, base detail of the 1875 frame.  
Photo: Miles Lewis.

In 1890 the Port Adelaide Light was replaced by a new structure in a nearby location, which re-used the same lantern. The existing structure was moved to South Neptune Island and fitted with a new second order dioptric lens. It operated on the new site from 1900 to 1985 when it was acquired by the South Australian Maritime Museum, and moved to its present location. Despite being enlarged at an early date, and moved twice, it is well-preserved. The lower part of the shaft is believed to be the 1869 structure, and the upper part, the flared top and the openwork surrounding frame that of 1875 (making it much more like a typical openwork lighthouse than it had been when first built), and the lantern that of c 1900. The wrought iron plates are simple curved sheets bolted to an angle iron framework, unlike the distinctive flanged cast iron tray construction used in Gordon's solid trunk lighthouses.

12 O.A. Babbage in the *South Australian Register*, 21 February 1866, p 2.

13 Wright & Wells in the *South Australian Register*, 1 February 1866, p 3. Even the replacement drawings are not known to survive, but there is another design using screw piles, prepared by William Hanson of the Architect's Office Adelaide, which seems never to have received serious consideration: Anderson, *Designing Lights*, pp 25-6.

14 Anderson, *Designing Lights*, p. 26.

15 *South Australian Register* (Adelaide), 28 June 1867, p.7.

16 *Ibid.*, 21 October 1874, p.4.

## Portable Engineering

A strange structural form found in a number of “portable” buildings made by Edwin Maw of Liverpool in about 1853-5 seems likely to have been derived from railway goods wagons. Known surviving examples are:

- Former Presbyterian Church 590 Comerong Island Road, Numbaa, New South Wales,
- All Saints Parish Hall [former store], 95 King William St, Fitzroy (a suburb of Melbourne), Victoria,
- Iron shed, Longford House, Longford, Tasmania,
- Shed at the Lucas Hotel, 46 Gilbert St, Latrobe, Tasmania.

Externally they are deceptively simple, with cast iron pilasters and a cladding of vertical corrugated iron between. But the corrugated sheets are attached to horizontal girts resembling bicycle chains, and the same chains are used for the top chord of the roof truss and (in at least one case) to tie the building horizontally below the flooring. The system provides a degree of flexibility in that the bolts which fix the cladding can be moved horizontally to any convenient position, and the cladding can be easily removed to open up the wall, or can even be replaced with a different material. This is the key to the origin of the system.



Former Presbyterian Church, Numbaa, New South Wales, 1855. Shows the face of the cast-iron stanchions along the wall. Photo: Miles Lewis.



Interior detail of the iron shed at Longford House, Longford, Tasmania. Shows corrugated iron wall cladding bolted to an iron wall girt. Photo: Miles Lewis.

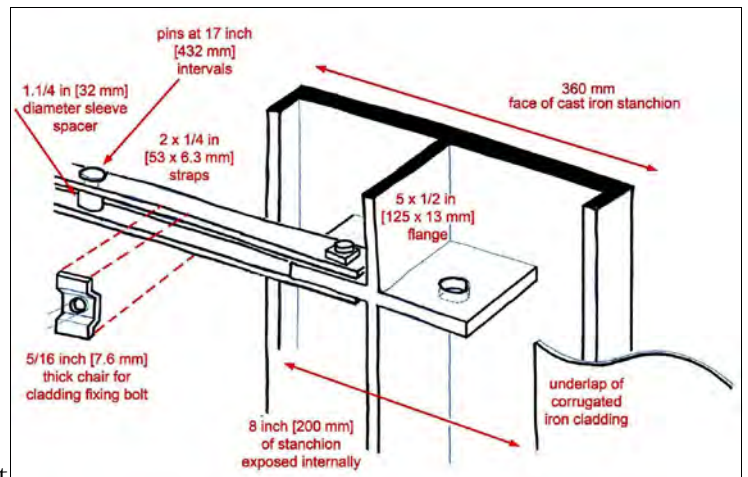

A diagram of the structure of Edwin Maw's buildings, with stanchion & girt, shown in the photos above and at left. Drawing: Miles Lewis.

In 1854 Maw was reported to have large premises at the back of the Wallasey Pool, Liverpool, England, for the manufacture of railway wagons, iron houses and other items.<sup>17</sup> The reference to railway wagons is an important clue, for his system seems particularly suited to goods wagons in which the sides might be open, or might be covered in canvas. It seems that he simply transposed this idea to his buildings.

Another interesting aspect of Maw's buildings is not unique, for it is shared with our next example, and with other buildings in Britain of around 1825-55. It is the Polonceau roof truss with ornamental bifurcated (or 'lily flower') cast-iron struts. For some reason British engineers (never French ones) commonly used this ornamental form, as shown at left in a detail from a section drawing of a Market House, Blackburn, England, by T. Flanagan, c1847. (*Practical Mechanics Journal vol.1, 1848-9*) A simple Polonceau truss contains only two short struts.

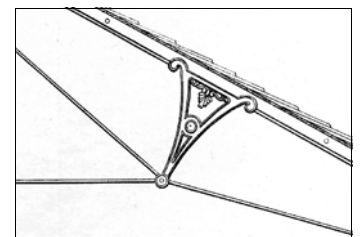

Our next example is a somewhat enigmatic building in Sydney which is now believed, following brilliant research by Hayley Edmonds, to have been imported for R.E. & F. Tooth's Kent Brewery in 1855. The existing Kent Brewery had been destroyed by fire in 1853 and it appears that a replacement building was designed and constructed in England for Tooth's Brewery under the personal superintendence of Outtrim, resident engineer at the Kent Brewery.<sup>18</sup> The ship's manifest gave the components as:

*One brewery - made of 288 girders, 79 columns, 138 pieces of framing, 8 tank pieces, 4 brackets, 33 foundation plates, 2 bundles plates, 4 pipes, 3 bundles rods, 15 bundles banister rails, 69 pieces staircase, 2 ditto hoisting tackle, 6 doors, 3 pieces door framing, 6 cistern plates, 2 stays for hoisting, 31 pieces guttering, 12 wall plates.*<sup>19</sup>

<sup>17</sup> *Liverpool Mercury*, 5 September 1854.

<sup>18</sup> *Sydney Morning Herald*, 21 June 1855, p 5.

<sup>19</sup> *Ibid.*, 14 June 1855, p 8.

## Portable Engineering

This iron Kent Brewery building was built in Parramatta St, Chippendale, Sydney,<sup>20</sup> and was moved to a site in Waterloo, Sydney, at an unknown date, possibly in the 1880s. There it was partly absorbed into a later structure, and was investigated by Godden Mackay Pty Ltd in 1990, and surveyed by Bob Irving. When the whole complex was demolished in 1992 the components of the iron building, the majority of which had survived, were put into storage until 2008, and then the frame was re-erected in a nearby park, with missing and damaged components replaced.<sup>21</sup>

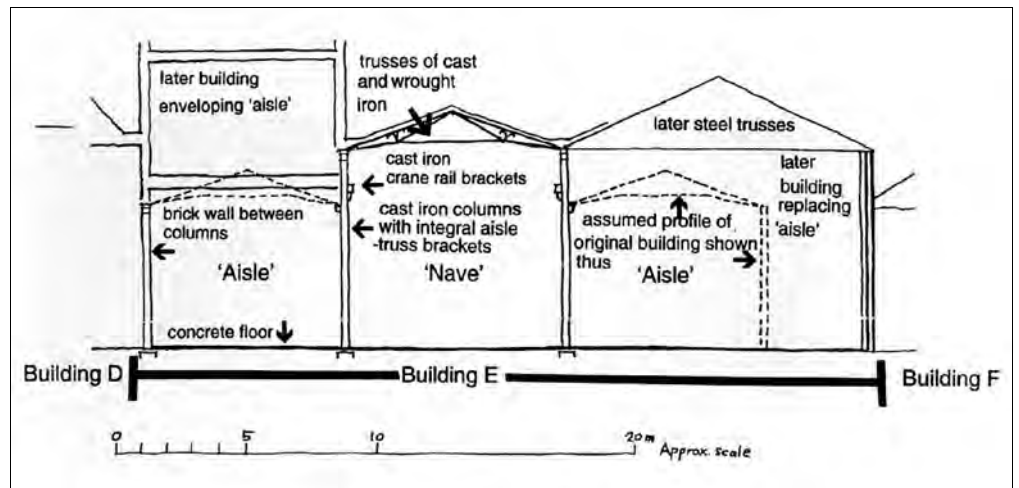

The complex of buildings containing the iron Grissell building as seen in 1990, before demolition in 1992. Section drawn by Bob Irving, 1990.



Detail of a branded column from the Grissell Building. Photo: courtesy GML Sydney.

The columns bear the brand of a leading London foundry: H. & M. D. GRISSELL, REGENTS CANAL IRON WORKS, LONDON.<sup>22</sup>

Those columns flanking the nave have brackets to carry a crane track, and a bracket at the top of each column supports the end of the triangular Polonceau roof truss. The travelling crane with three way motion had been perfected only around 1851, and it is relevant that travelling cranes were also shown in an engraving of the Grissells' Regents Canal Works in 1855.

The Polonceau trusses with flat tie bars, rolled tee rafters, cast iron struts of the 'lily flower' pattern with four fronds, and rectangular gusset plates at the apex, all match those of the Grissells' own building at Chatham.<sup>23</sup> The lily flowers are also similar if not identical to those in the Polonceau trusses of Edwin Maw's prefabricated iron church at Numbaa, as is shown on the previous page.



The re-erected nave of the Grissell building.

Photo: International Conservation Services (ICS).



A replicated lily-flower strut as used in the re-erected Grissell Building. Photo: ICS.

- 20 The new building was described in detail in the *Sydney Morning Herald*, 21 June 1855, p 8. The site was bounded by Parramatta Street, Kensington Street and Charles/Balfour Street.
- 21 The engineers were Hughes Trueman (today Mott Macdonald Hughes Trueman) and the work was done by International Conservation Services.
- 22 Survey sketches by Robert Irving behalf of Godden Mackay Pty Ltd. March 1990, and inspection by myself April-May 1991. This is at the former Mauri Brothers & Thompson site, Bourke Street, Waterloo.
- 23 Malcolm Tucker advises that David Evans, *Building the Steam Navy* (2004), figs 41B, 44, shows very similar cast iron struts in a multiple bay roof built by Henry Grissell c 1845 for the Chain Cable Store at Portsmouth. That roof used round bars for the tie-rods, with neat but necessarily more expensive forged ends: email 7 June 2021 <[malctt@tiscali.co.uk](mailto:malctt@tiscali.co.uk)>.

## Portable Engineering



Cast iron reservoir made for the Walka Water Works by the Birtley Iron Co, Newcastle, UK, c 1877, now at 147 Ocean St, Dudley, near Newcastle, NSW. The reservoir was still in use and well maintained when it was photographed in 1992. Photo: Margret Doring, 1992.



Joint in a malleable iron strap, Dudley Reservoir. Photo: Margret Doring, 1992.

Two further structures in New South Wales deserve mention. A cast iron reservoir now at Dudley was apparently one of a number made for the Walka Water Works by the Birtley Iron Co. of Newcastle, UK, in 1877.<sup>24</sup> It is not structurally remarkable, but it is an exceptionally beautiful piece of technology, consisting essentially of an assemblage of cast iron plates all bound together with malleable iron straps.



Maker's Mark, Dudley Reservoir. Photo: Margret Doring, 1992.

In 1886 an iron retort house was brought out from England for the North Shore Gas Company's works at Neutral Bay, Sydney. The company's engineer, Thomas Morland, had been recruited from England in that year, which may explain his loyalty to English sources. A surviving, but deteriorated drawing is too generalised to convey the technical details, but it shows the overall form of the frame and the system of lettering used to identify the components, which were, reportedly, cast iron structural members and corrugated iron cladding.



The interior of the former Gas Retort House, now at the RAN sub-base Platypus. Image: courtesy Rosemary Broomham.

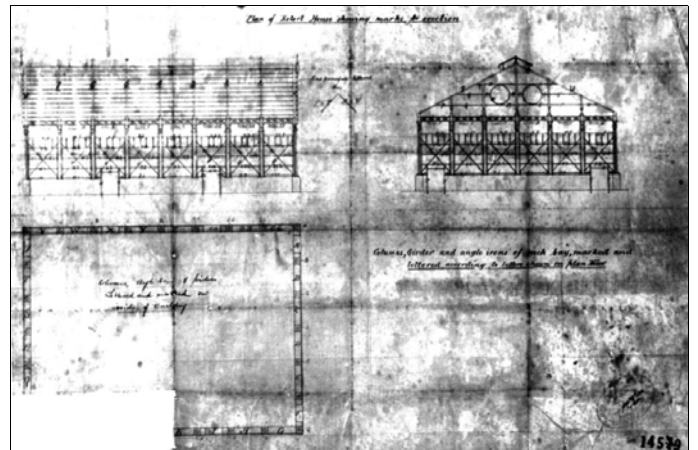

Part of a surviving drawing of the iron Retort House Neutral Bay, Sydney built by John Abbott & Co, Ltd. 1886. Image: courtesy Rosemary Broomham.

The drawing is stamped 'John Abbot & Co. Limited, Steam & Hydraulic Engineers, Park Works, Gateshead on Tyne', and dated 9 September 1886. Abbot is not a known manufacturer of buildings, and was obviously engaged because his expertise in gas engineering, so it is not impossible that the structure was subcontracted to some unidentified fabricator.<sup>25</sup>

The structure is now building 11 on the Royal Australian Navy's Sub-Base Platypus on the former gasworks site.

24 C & MJ Doring P/L and John Turner, *City of Lake Macquarie Heritage Study* (Suters Architects Snell, Newcastle, NSW, 1993), item DL-01.

25 Information and drawings supplied by Rosemary Broomham, 1995; also an extract from Rosemary Broomham, 'Neutral Bay; a history of the Neutral Bay Gas Works', *Flame* (unidentified number, 1986).

## Portable Engineering

At Broome in Western Australia an Historic Engineering Marker commemorative plaque has been placed by Engineers Australia to mark the landfall of the cable which was laid from Banjoewangie, Dutch East Indies [Indonesia] early in 1889, because the submarine cables to Darwin had been regularly broken by volcanic activity. A more substantial reminder and a most interesting structure is the cable repeater station constructed at this time, now the Broome courthouse.



The Broome Cable Repeater Station (now Courthouse). Photo: Brian Kidd.

The repeater station was the grandest building in the whole of northwest WA, which was only just being opened up for grazing licences. It was manufactured by Frederick Braby, of London and Glasgow. The Cable Ship *Seine* left the Thames on 31 December 1888, carrying the ironwork for the building, and between 7 and 10 February 1889 took on a load of teak wood (probably dedaru) at Singapore to complete it, and apparently a gang of Chinese coolies to do the work.

Although the structure was loaded at London, the verandah columns carry the brand of the Glasgow works of Frederick Braby & Co, and they may perhaps have been stock items already held at Braby's London branch. However the design of the building was carefully adapted to tropical conditions, with a wide verandah, double roofing and a central ventilating lantern. Its elevation on stumps, about 1.2 metres high, was also relatively unusual at the time. The imported timber was used to line the building – something not envisaged by the manufacturer – and additional rooms were constructed on site.

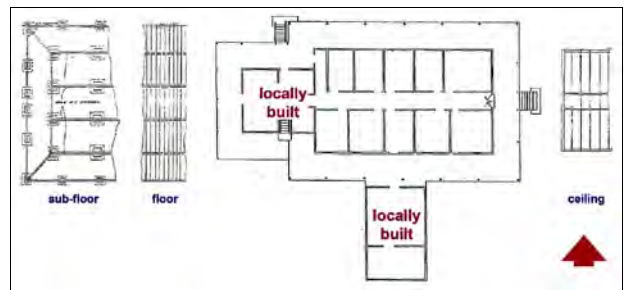

Reconstruction of Broome Cable Repeater Station plan, by M. Lewis. Derived from "Plan showing conversion of the Cable Station 1922." Dept. of Nth West WA drg No.108, PWD WA drg No.21441.



Detail of the Fred Braby & Co. Ltd. brand on a verandah column of the Broome Cable Repeater Station. Ph: Brian Kidd.



London & Hamburg Gold Recovery Company Assay Office, built in 1898 in Kalgoorlie, WA.. Photo: Miles .Lewis.

At Kalgoorlie in WA, is one of our few non-British prefabricated structures. It was imported from Germany and put up probably in 1898 as an assay office for the London and Hamburg Gold Recovery company on Hannan's Brown Hill mining lease near Kalgoorlie.

It was bought by the Commonwealth government in 1921 and moved to the Commonwealth Health Laboratory in Kalgoorlie, where it still stands off Maritana Street, now part of Kalgoorlie Hospital. The bulk of the building is timber. The external walls are framed in steel and there is a steel beam around the periphery of the verandah floor. The steel is stamped PEINER WALZWERK NP18 1897. Peiner Walzwerk was a steelworks in Peine, between Hanover and Wolfsburg, and NP 18 is Normprofil (standard profile)

dimensions for I shapes. Although German steel was now generally better than British, not much of it is found in Australia because (just as with Portland cement) colonial consumers loyally stuck with British producers.

The roof is double with a substantial space between the two layers, totally open around the periphery (apart from mesh), and the building stands upon cast iron pillars which incorporate cups for ant poison. These pillars look very modern, but they appear to be original, and they certainly show on the drawing done for the removal of the building in 1927.<sup>26</sup>

Prefabrication certainly did not cease after 1900, and indeed there was a huge boom in imported houses after World War II, but there are now very few fully prefabricated engineering structures.



London & Hamburg Gold Recovery Co.. assay office, vermin-proof pillar: Photo: Miles Lewis.

<sup>26</sup> Inspection 2008, supplemented by material on display on site and material on the State Heritage Register, No. 3326.

# CSIRO's Parkes Telescope: 60 years old & still going strong.

By John Sarkissian, OAM

Operations Scientist, CSIRO Parkes Telescope

The CSIRO's 64-metre Parkes Radio Telescope was commissioned on 31 October 1961. At the time, it was the most advanced radio telescope in the world, incorporating many new innovative design features that have since become standard in all large, dish antennas. Through its early discoveries it quickly became the leading instrument of its kind in the world. Today, over 60 years after it was commissioned, it is still arguably the finest, single-dish radio telescope in the world. It is still doing world-class science and making discoveries that are shaping our understanding of the Universe. We take a look at the reasons for the telescope's success and longevity and try to peer into the near future to see what may lie ahead for it.



Parkes Radio Telescope under construction circa 1961.

Source: CSIRO.

The telescope was originally expected to operate for twenty years only, so we have well and truly exceeded that expectation. There have been many reasons for this longevity. Its location in the Goobang Valley, just north of the town of Parkes in the Central West of NSW, was chosen for its lack of radio frequency interference (RFI). A large antenna like Parkes, is incredibly sensitive to local radio interference. The region around the Goobang Valley shielded the telescope from the radio emissions from the larger population centres further east such as Orange, Bathurst, Lithgow and of course, Sydney.

Today, despite the increase in radio interference from modern electronic devices such as mobile phones and WiFi, the Parkes site is still quite good and useful work can still be undertaken there. Another

great advantage of the site is its location on the Earth's surface. From these latitudes the centre of the Milky Way Galaxy passes almost directly overhead, so the richest and most interesting parts of the Galaxy are easily accessible from Parkes and gives it an advantage over almost all other large radio telescopes.

Another reason for its success was the design of the telescope. The design engineers were the British firm of Freeman Fox & Partners, to the specifications of CSIRO. The famous British engineer, Barnes Wallis, of "Dam Busters" fame, suggested many new, innovative design features which were adopted by Freeman Fox. For example, it was the first large radio telescope to be mounted from the centre, like an inverted umbrella. All previous large antennas were mounted on the edges like inverted bridges, which made pointing the telescope very difficult.

Image at Right: The face of the Parkes Radio Telescope dish as it appeared in 1969, viewed from the south east. The structure at the top of the tripod legs is the Focus Cabin. The small subsidiary dish in the background is now disused, but was still in use in 1969.

Source: CSIRO.





## CSIRO's Parkes Telescope: 60 years old & still going strong.

However, the innovative features alone do not explain the longevity of the telescope. Rather, the telescope has been constantly upgraded over the years. The most obvious upgrades have been to the dish surface. Originally, the entire surface was made of steel, wire-mesh panels which extended all the way to the centre. However, beginning in 1970, the surface has been progressively upgraded, with the steel wire-mesh panels progressively replaced by perforated aluminium panels. These have made the telescope more sensitive to the higher frequencies. The most recent surface upgrade was in 2003 when the aluminium panels were extended to the inner 55 metres of the dish. Another major upgrade was to the Focus Cabin. The new cabin is twice the size and weight of the old cabin. It is capable of housing up to four radio receivers. This has made the telescope more frequency agile and efficient in the way it is used and has increased the productivity of the telescope many-fold. Consequently, many different types of observations are possible within a short period, leading to more opportunities to do world-class science and to follow up observations of rapidly changing phenomena.



Fox Mason working at the original control desk in 1970. Neil "Fox" Mason, was a telescope driver. He was a local staff members who operated the telescope for the astronomers. A few months earlier in July 1969, he drove the dish during the Apollo 11 moonwalk. Source: CSIRO

Another source of the telescope's success has been the constant upgrading of its processing instrumentation. When it was first commissioned, the most common recording device was a chart recorder and analysis was performed with a slide-rule. Eventually, the Observatory's first computer was installed in 1968. It was a PDP-9 with a paper tape output and was the same one featured in the film, *The Dish*. Since then, every function of the telescope has been fully computerised. All of the data is digitised and stored onto magnetic disks before being transported around the country, and the world, via dedicated fibre-optic lines with a 1 Gbps capacity, and upgradable to 10 Gbps if required. This is essential because of the enormous volume of data being recorded. A typical observing session today can record several terra bytes of data. In fact, there is so much data being recorded that the archiving

capacity is constantly being challenged. The new, innovative observations demand a vast amount of memory space and this will only increase further in the coming years. New data capture and processing equipment is constantly being designed and installed to meet this demand. We've moved from chart recorders to supercomputer clusters utilising the latest Graphics Processing Unit (GPU) and radio frequency over fibre (RFOF) technologies. It has been an incredible transformation.

The telescope's receiving systems have also been extensively upgraded over the years. When commissioned, simple dipole receivers were used to detect the radio waves at the focus. These essentially operated at room temperature and were not very sensitive. Eventually, cryogenically cooled receivers were developed that operate around 20 Kelvin ( $-253.15$  degrees Celsius), vastly increasing their sensitivity.



Image at Right:

The control system was upgraded and computerised in the mid-1980s. This photo shows Dick Manchester, a distinguished pulsar astronomer, working on the control desk in the mid-1990s. Source: CSIRO.

## *CSIRO's Parkes Telescope: 60 years old & still going strong.*

In 1997, this technology was further advanced when the Multi-Beam (MB) receiver was commissioned. Up until then, conventional receivers could only detect radio signals coming from single points on the sky. These single feed receivers would sit at the focus of the parabolic dish, only detecting the signals focused at that point. However, the telescope has a focal plane, that is, a region around that focus point where the signal is still quite strong. It was realised that by placing several receivers on the focal plane, multiple adjacent points on the sky can be observed at once. Consequently, a focal plane array receiver with 13 feeds, was built and installed in January 1997. This allowed astronomers to 'see' 13 points simultaneously on the sky and to conduct surveys 13 times faster than in the past. You can think of it as a 13-pixel radio camera. It's not much compared to today's multi mega-pixel optical cameras, but it was a great improvement on the single pixel, conventional radio receivers.

This Multi-Beam receiver rejuvenated the Parkes telescope. It led to several ground-breaking surveys that doubled the total known number of pulsars, including the discovery of the only known double pulsar system in 2003. It also allowed astronomers to probe the Universe and plot the positions of galaxies out to 300 million light years and to peer through the obscuring dust of the Milky Way to see what lay behind for the first time. It revolutionised the way radio telescopes conducted surveys. Several MB receivers were subsequently built by CSIRO for other observatories around the world including at Jodrell Bank Observatory in the UK, Arecibo Observatory in the USA, and the FAST telescope in China.

The sum result of all these upgrades, both external and internal, is that today, the Parkes telescope is over 10,000 times more sensitive than when it was built. In fact, the only parts of the telescope that are 60 years old, are the concrete and steel it is made of – in many ways it is a young telescope.

The way the telescope operates has also changed over time. At first, dedicated telescope drivers were employed to drive the telescope for the astronomers. The old control desk, with its dials and globe, was too complicated to entrust to inexperienced astronomers. Over time, this became a very inefficient and costly way of operating the telescope. With new equipment and observing techniques being developed, it was time for a change. In the early 1980's, the entire control system was replaced by a new computerised system. Now, astronomers could be trained to operate the telescope more efficiently, and conduct more complicated observations. It also helped that it kept the operating costs down, so that money was freed to develop new equipment and to build a new observatory, the Compact Array, at Narrabri. The control system was further upgraded and modernised in the late 1990's when the MB receiver came online. With the vast increase of internet speeds, it was decided in the late 2000's to further upgrade the operations and allow remote observing to be undertaken. The entire control system was modified so that astronomers could connect via the internet and to safely control the telescope from a remote location such as their office or home, or from anywhere in the world. This allowed savings to be made and has increased the efficiency of the telescope further.

The improvements to the telescope have meant that new discoveries are being made all the time. One fine example is the discovery of Fast Radio Bursts (FRBs). These are sudden, single bursts of radio energy that last only a few milliseconds. Their origin is a complete mystery. From the nature of the signals detected so far, they appear to come from extra-galactic sources, billions of light years from the Earth. This implies that the energy release is enormous. The first FRB was discovered at Parkes in 2007 by British astronomer, Duncan Lorimer, and his colleagues. He was searching through some archived data taken with the MB receiver in 2001, looking for giant pulses from pulsars. Instead, he came across an ultra-bright burst from a single point on the sky. The dispersion of the signal, indicated it was very distant.

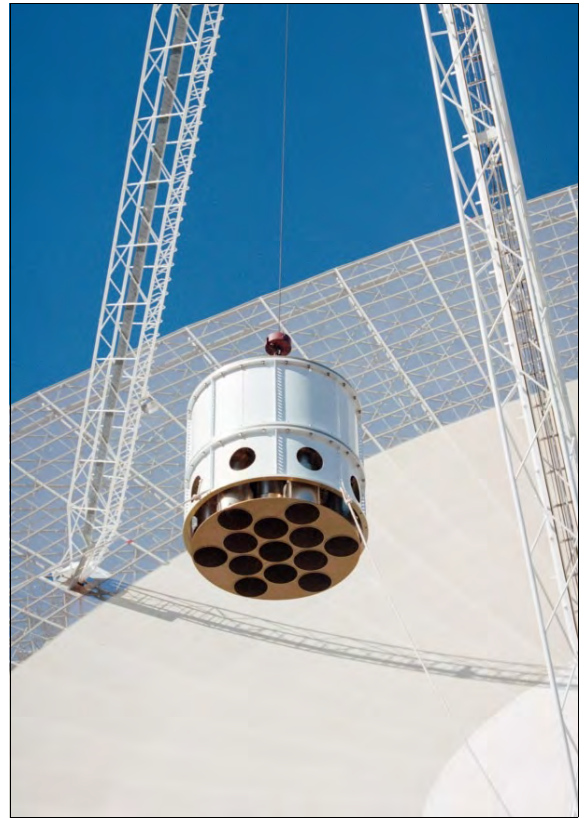

The Multi-Beam Receiver (MB) being hoisted into position in the Focus Cabin at the top of the tripod in 1997. 13 receiver feed horns are inside the 13 inlet holes in the underside of the MB.  
Photo: John Sarkissian.

## CSIRO's Parkes Telescope: 60 years old & still going strong.

When it was observed again, to see if it could be re-detected, nothing was ever seen of it. Then over the next few years, more of these were found in the archived data, coming from other points in the sky, and in new observations. Interest began to increase. Slowly, other observatories discovered more FRBs, and for the first ten years, Parkes held the record for the number found. The statistics suggest there should be thousands of these bursts every day, but you need to observe at the right point, at the right time, at the right frequency and with all the right equipment and processing software to detect them. With the MB surveys and with the right kind of equipment, Parkes was the ideal place to discover them. Are FRBs a new class of object? Are they formed by colliding neutron stars, black-holes or some other cataclysmic event? No one knows for sure. But it is fascinating to watch an entirely new field of astronomical research taking shape before our eyes.

In order to further study these intriguing objects, and much more, a new suite of radio receivers was built for Parkes. The first was an ultra-wideband (UWB) receiver. It will operate over a very wide band of frequencies ranging from 700 MHz to 4 GHz. This is many times the frequency range of existing receivers.

Another new form of receiver developed by CSIRO is a Phased Array Feed (PAF) receiver. PAFs are many little antennas placed on the focal plane of the telescope. Each of the antennas can be linked together, or phased, in such a way that many points can be observed on the sky, at once. These PAFs were developed by the CSIRO to operate on the next generation of radio telescopes. The PAFs can generate 36 beams simultaneously. This will greatly increase the speed that surveys can be conducted, and they represent the future of radio astronomy. In 2020, work began on a cryogenically cooled PAF specifically for the Parkes telescope. This receiver will be even more sensitive than the existing PAFs and will be capable of projecting 72 beams onto the sky. Its installation will begin in late 2022 and it will be an ideal instrument in searching for FRBs. Together with the UWB receiver, the cryo-PAF will allow more than 90% of current Parkes operations to be made with no receiver changes, greatly improving the efficiency of Parkes operations.

In 2016, the *Breakthrough Prize Foundation* in the United States, began a Search for Extra-Terrestrial Intelligence (SETI) project. This SETI project is known as Breakthrough Listen. Over a ten-year period, USD \$100 million is being invested by Breakthrough Listen on this global SETI initiative. The Parkes telescope is essential for the scientific integrity of the SETI program. It is ideally located and perfectly positioned to provide the best and most powerful view of our galaxy. Work with Parkes began in October 2016 and will run until 2026. Breakthrough Listen is an exciting project that inspires the public and ensures the future viability of Parkes. The chances of finding anything are very small, but the consequences are enormous, if anything is found. For this reason, it is an extremely worthwhile undertaking.

Though Parkes was designed primarily as an astronomical instrument, its innovative design was recognised early on by NASA to be a near-ideal instrument for tracking spacecraft in deep space; that is, at the orbit of the Moon and beyond. In 1960, one year before the telescope's construction was complete, the CSIRO was approached with a proposal to include the telescope in NASA's fledgling, Deep Space Network (DSN). The CSIRO agreed that whenever a strong, reliable signal was required, especially during critical moments like planetary flybys or landings, then the Parkes telescope would support the missions for those brief periods. Consequently, beginning in December 1962, Parkes tracked the very first interplanetary mission, Mariner 2, as it flew by Venus. This was a test track that proved to be so successful that NASA decided to model its planned large tracking antennas on the Parkes telescope's design, which is why they were all originally 64-metres in diameter. Parkes then followed up by tracking Mariner 4 in July 1965, as it flew by Mars and received the first ever closeup pictures of the Martian surface. These early years culminated with the manned Apollo lunar landings from 1969-72. Over a decade later, Parkes was called in to help track Voyager 2 as it flew past the outer planets, Uranus and Neptune, in 1986 and 1989 respectively.



Lifting the prototype cryogenically cooled Phased Array Feed (PAF) into the focus Cabin for testing in 2016.  
Photo: John Sarkissian.

## CSIRO's Parkes Telescope: 60 years old & still going strong.



The most recent, upgraded Control Desk and Control Room, photographed on 14 March 2009. The 1980's control desk was decommissioned in the late 1990s and the control room was moved down stairs to its present location. There is nothing left of the 1980's control desk. Two PhD students observing in the most recent Control Room were Justin Bray (In blue polo shirt) and Clancy James (In red polo shirt).  
Photo: John Sarkissian.

In 1986, Parkes acted as the prime receiving antenna for the European Space Agency's Giotto mission to Halley's Comet. Then followed the year-long support of the Galileo mission to Jupiter in 1996-97, the Mars missions in 2003-04, and the Huygens probe landing on Saturn's largest moon, Titan, in January 2005. More recently, Parkes tracked the Curiosity rover's landing on Mars in 2012, and the Voyager 2 crossing into interstellar space in 2018. But the story hasn't finished yet. In early 2021, CSIRO signed a contract for Parkes to track the next generation of commercial lunar landers, beginning in early 2023. These missions will continue the proud legacy of Parkes' involvement in space tracking.

The great advantage of the Parkes telescope has been its incredible

flexibility and versatility. Although it was initially designed as a survey instrument, its versatility has meant that it is capable of performing many different types of observations. From discovering quasars, pulsars and molecular clouds to tracking spacecraft or searching for ET. It can do many things efficiently – and very well.

But in the end, what makes Parkes such a great instrument are the people who use it, the engineers and programmers who design and build the new equipment, and the people who maintain it. This attracts the very finest astronomers, who devise new observing techniques and clever ways to extract more information from the data. It is these people who realise that a new, unusual signal is interesting and worth following up on, with a curiosity to get to the bottom of the mystery. The Parkes telescope has been fortunate to have these inspiring people work on it.

Parkes has maintained its world-leading position in radio astronomy by constantly adapting and changing to meet new requirements. Today's improvements and upgrades are just the latest in a spectrum of change that has made the CSIRO's Parkes telescope Australia's premier scientific instrument. It is an iconic telescope with a great legacy of world-class science and discovery. Now, more than sixty years after its commissioning, the future looks bright at Parkes.



Image at Right:  
The modern Parkes Telescope photographed on 3 March, 2022. The dish surface as it appears today, after the last of the surface upgrades and with the new 3-sided focus cabin.  
Photo: John Sarkissian.